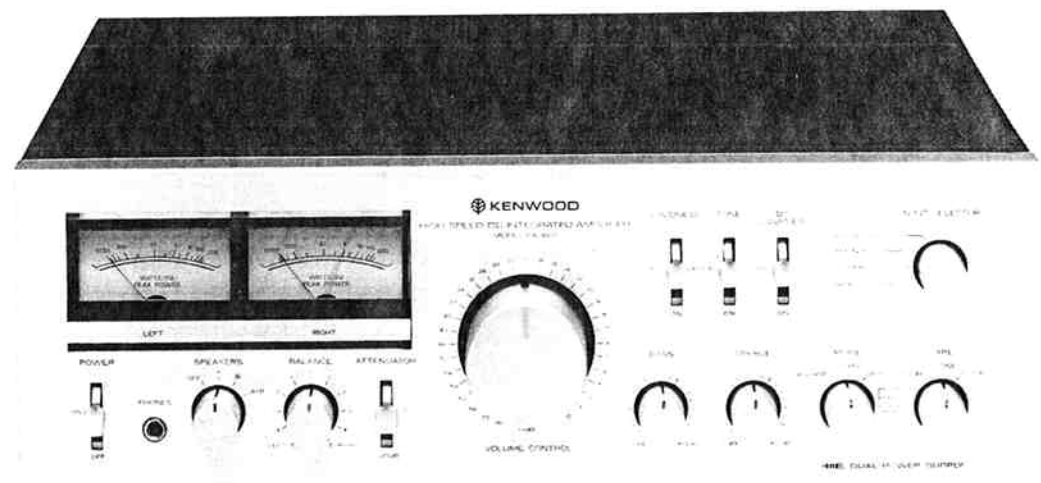




**KENWOOD**  
HI/FI STEREO COMPONENTS

# SERVICE MANUAL

**KA-801**  
**(KA-8011)**



**HIGH SPEED DC INTEGRATED AMPLIFIER**

**CONTENTS**

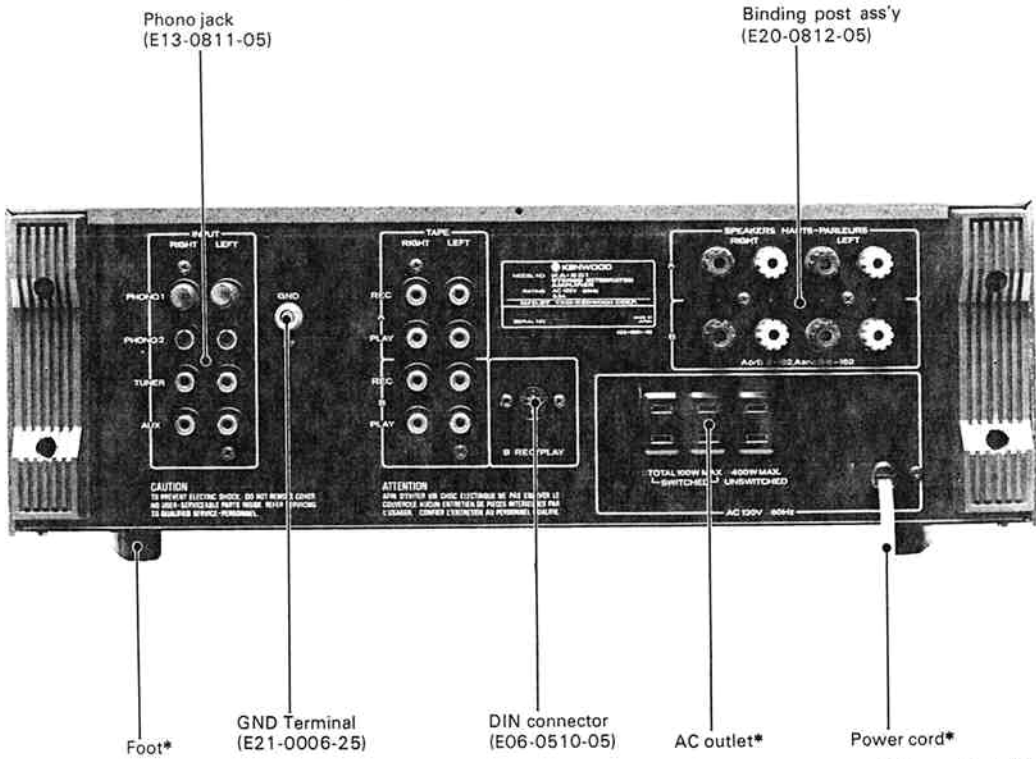
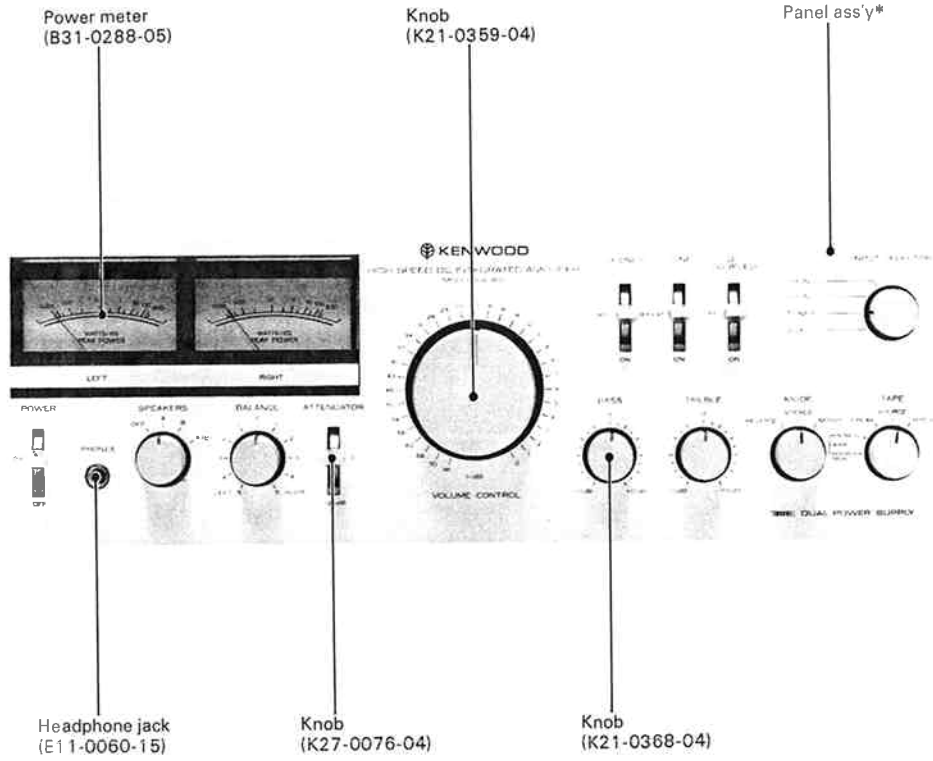
EXTERNAL VIEW.....	3
INTERNAL VIEW.....	4
BLOCK DIAGRAM.....	5
LEVEL DIAGRAM.....	5
DISASSEMBLY FOR REPAIR.....	6
EXPLODED VIEW.....	8
EXPLODED VIEW PARTS LIST.....	9
PARTS LIST.....	10
CIRCUIT DESCRIPTION.....	12
ADJUSTMENT.....	18
PC BOARD.....	21
SEMICONDUCTOR SUBSTITUTIONS.....	22
SCHEMATIC DIAGRAM.....	23

**Note:**

Component and circuitry are subject to modification to insure best operation under differing local conditions. This manual is based on, the U.S. (K) standard, and provides information on regional circuit modification through use of alternate schematic diagrams, and information on regional component variations through use of parts list.

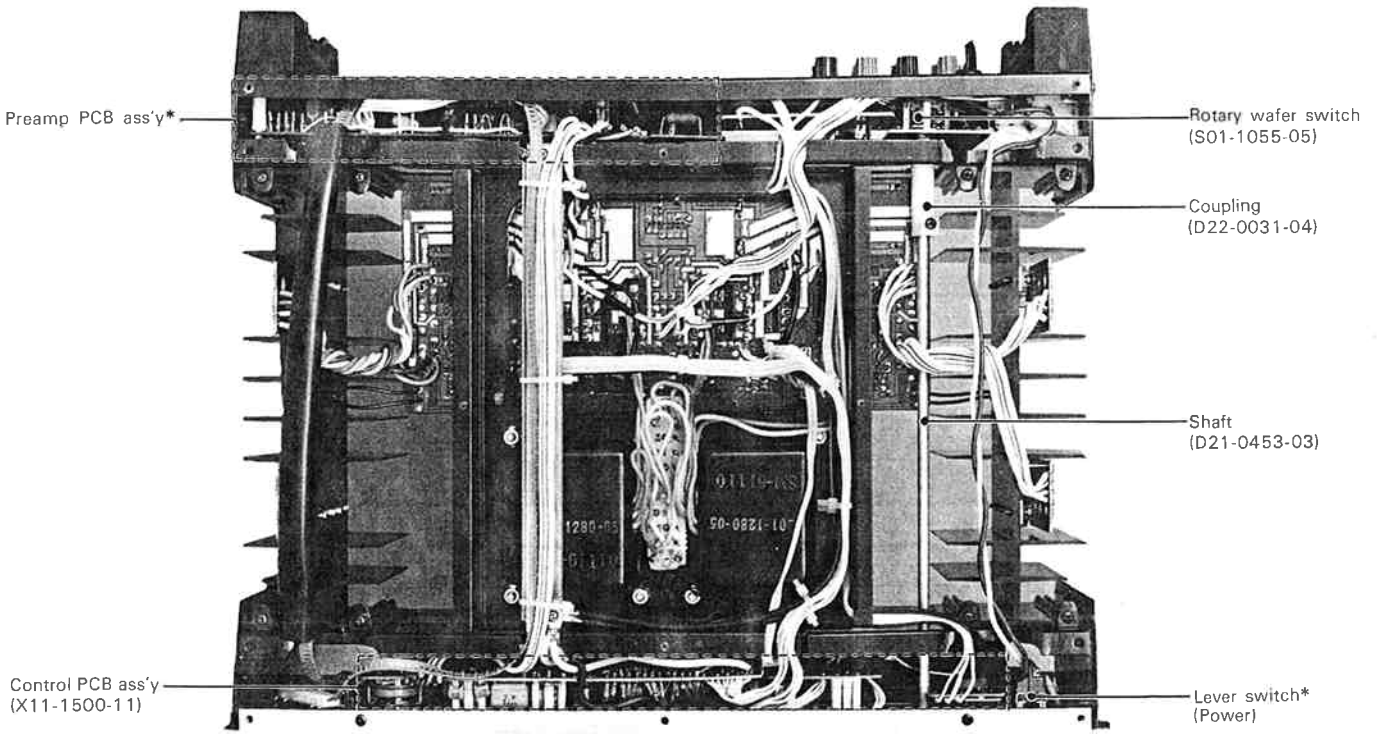
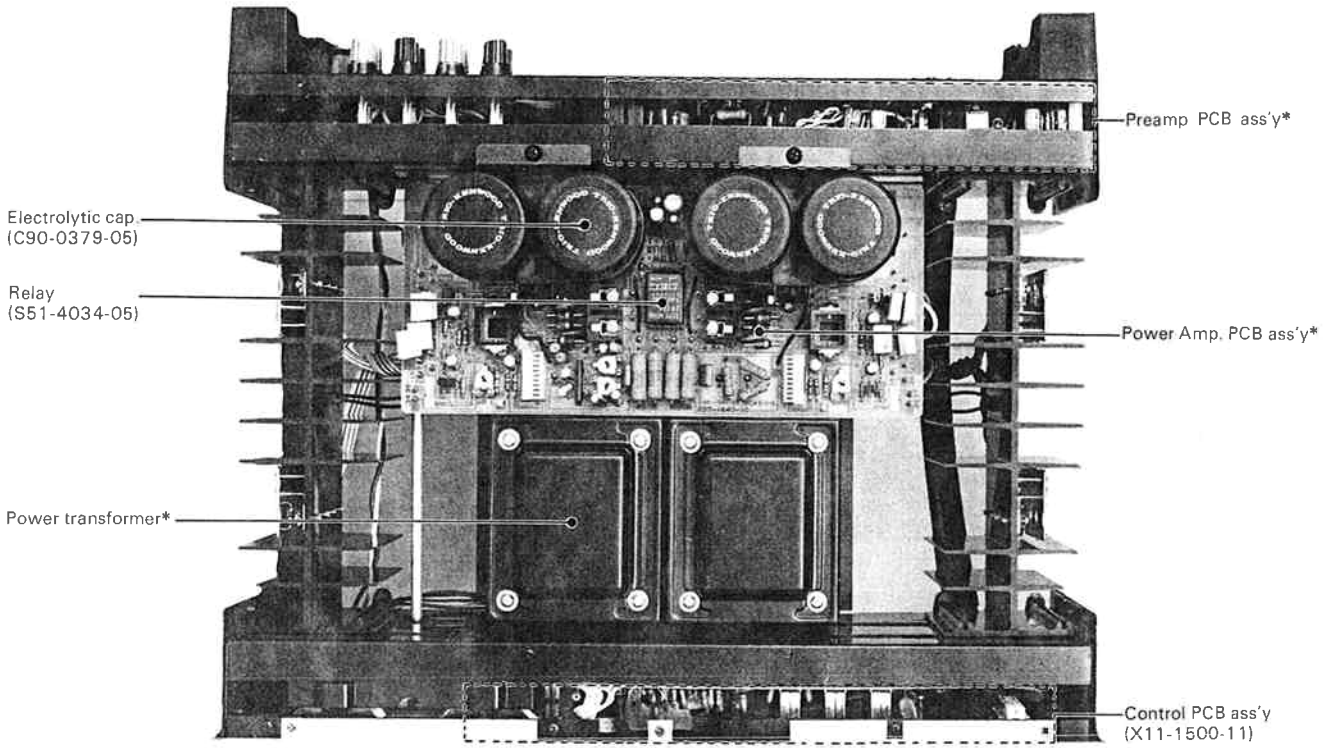
Region	Code
U.S.A. ....	K
Canada.....	P
PX.....	U
Australia.....	X
Europe.....	W
Scandinavia.....	L
England.....	T
South Africa.....	S
Other Areas.....	M
Audio Club (KA-8011).....	H

**EXTERNAL VIEW**



\* Refer to Parts List.

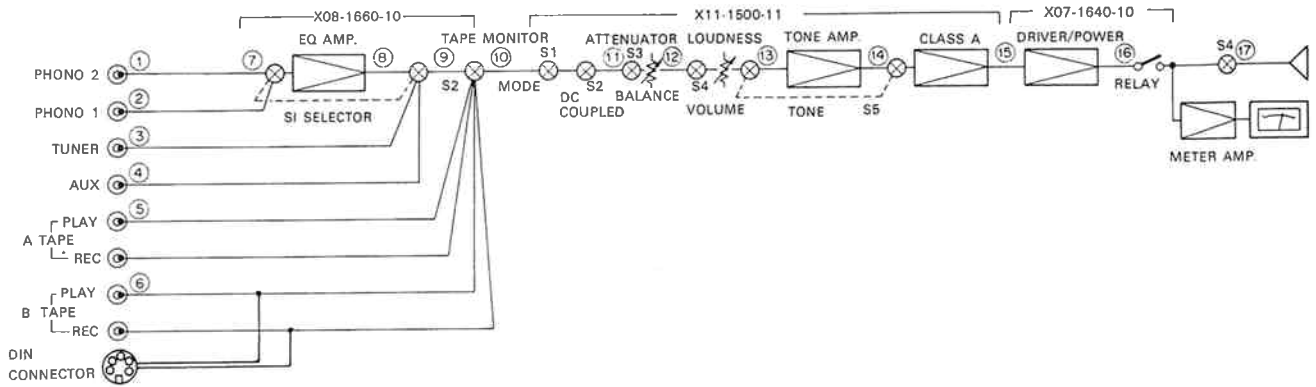
## INTERNAL VIEW



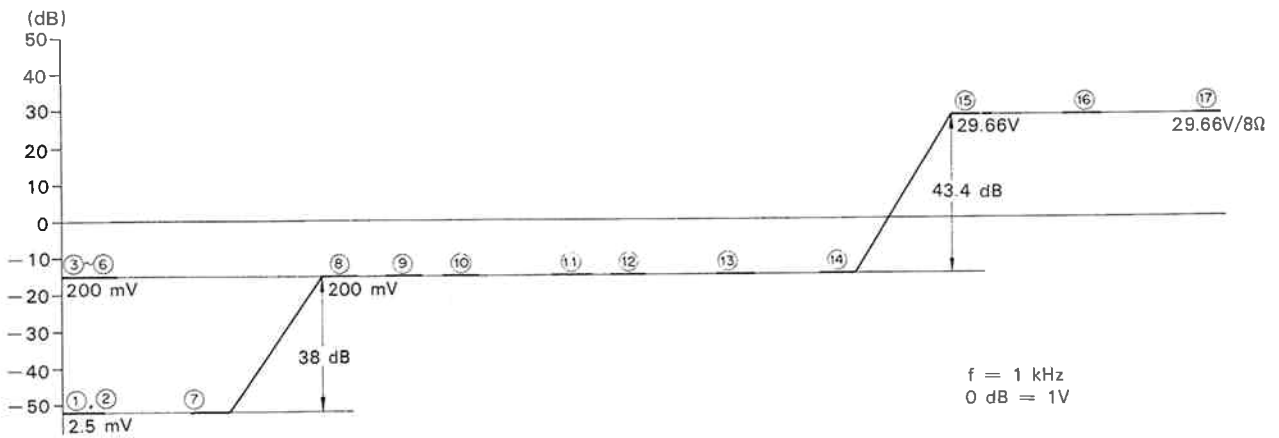
\* Refer to parts list

## BLOCK AND LEVEL DIAGRAM

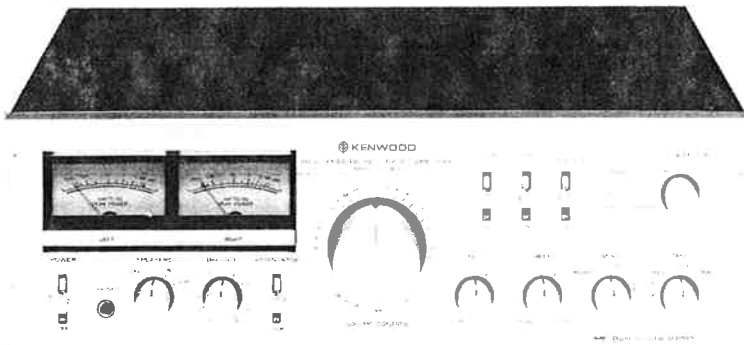
### BLOCK DIAGRAM



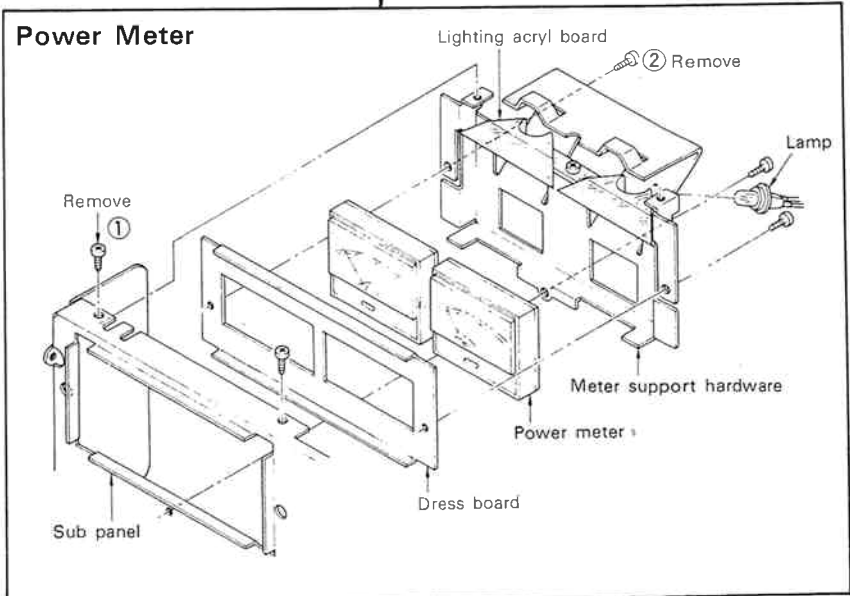
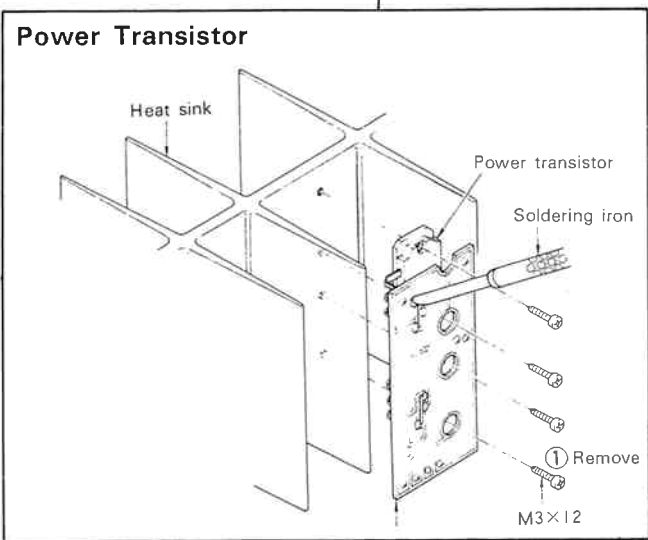
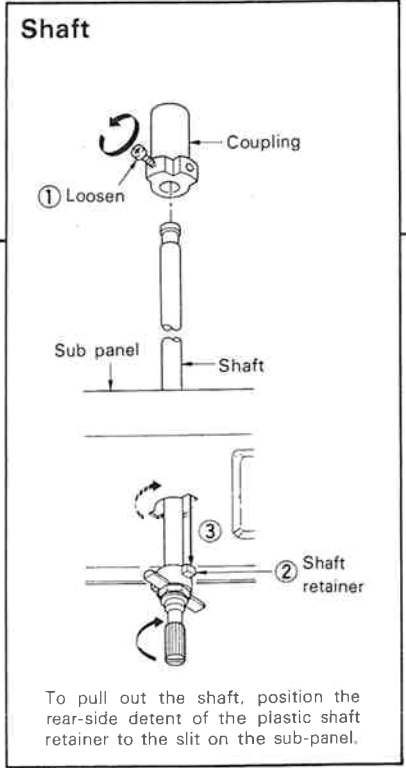
### LEVEL DIAGRAM



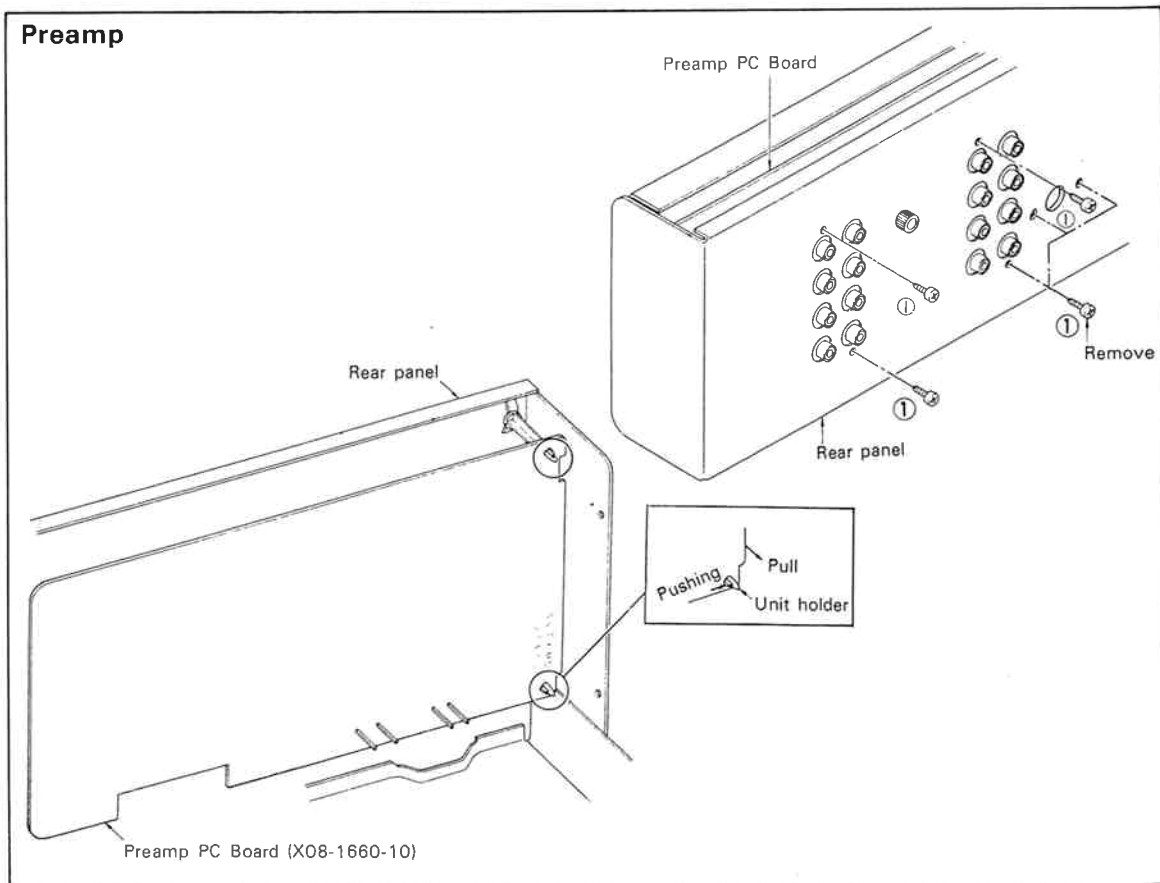
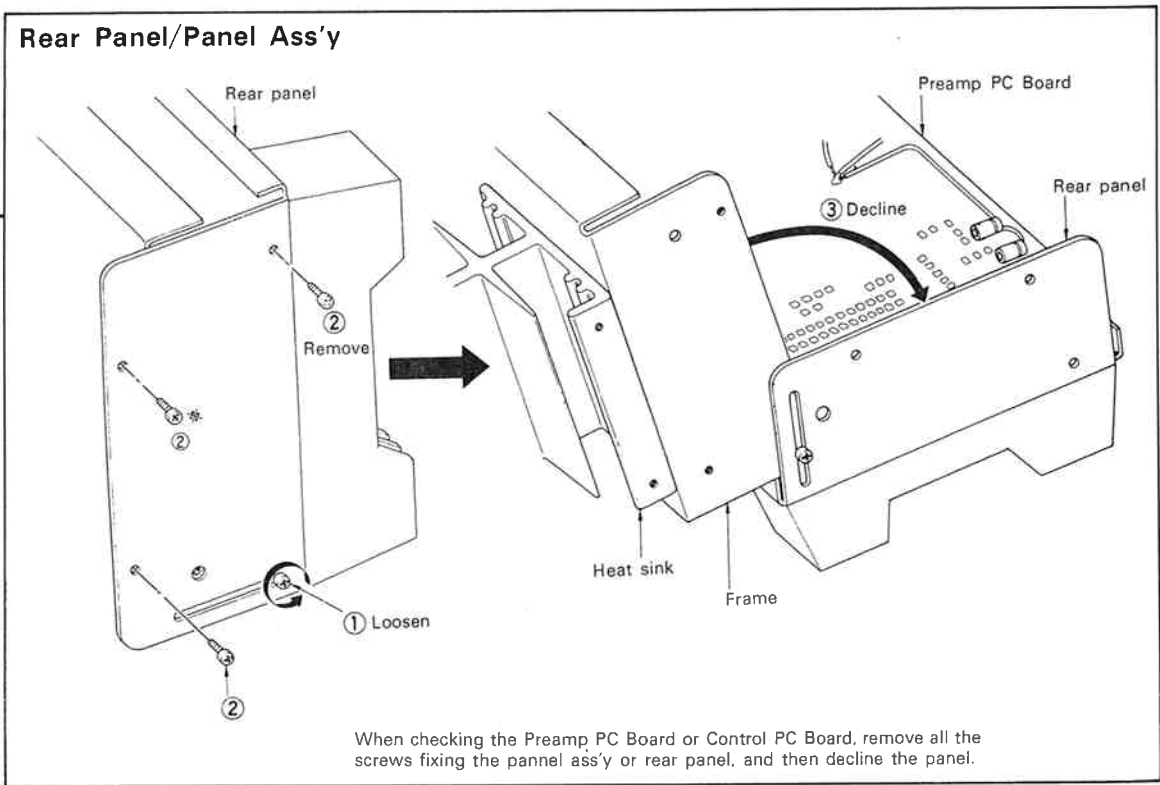
## DISASSEMBLY FOR REPAIR (1)



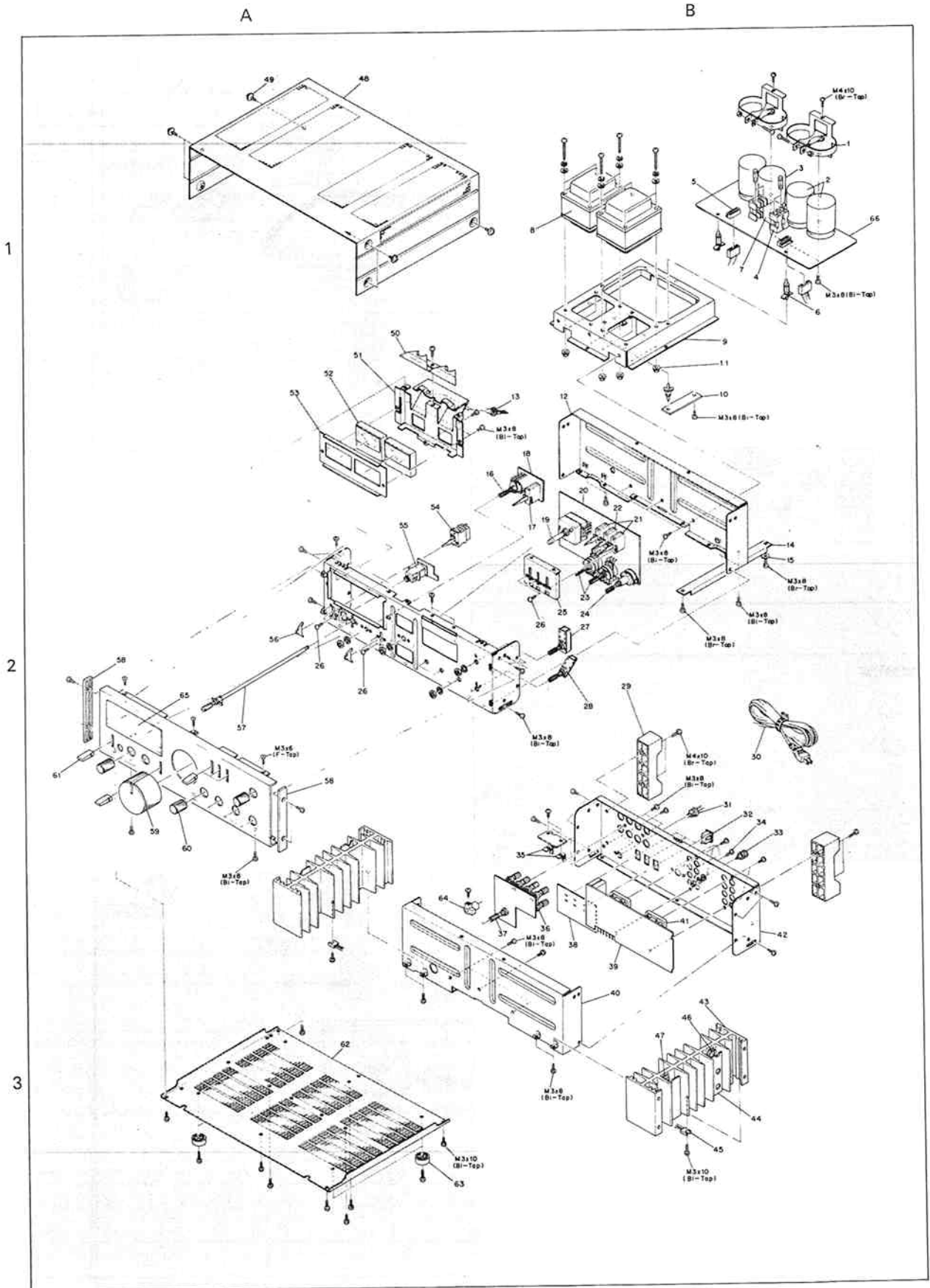
Remove the bottom plate and case.  
(Refer to Exploded View.)



## DISASSEMBLY FOR REPAIR (2)



**EXPLODED VIEW**





## EXPLODED VIEW PARTS LIST

\* : Refer parts list. ☆ : New parts

Fig. No.	Parts No.	Description	Re- marks	Fig. No.	Parts No.	Description	Re- marks
1	—	Capacitor band	1B	60	K21-0368-04	Knob	☆2A
2	C90-0379-05	Electyric cap. 10000 $\mu$ F 63WV	☆1B	61	K27-0076-04	Knob (Lever)	☆2A
3 *	F05-	Fuse (5A)	1B	62	—	Bottom plate	☆3A
4	J13-0058-05	Fuse holder	☆1B	63 *	J02-	Foot	3A
5	—	Pin ass'y	1B	64	D22-0031-04	Coupling	3A
6	—	Unit holder	1B	65	—	Front glass	☆2A
7	S51-4034-05	Relay	1B	66 *	X07-1640.**	Power amp PCB ass'y	☆1B
8 *	L01-	Power transformer	☆1B				
9	—	Chassis	☆1B				
10	—	PC board	☆1B				
11	N14-0115-05	Nut	1B				
12	—	Frame	☆1B				
13	B30-0167-05	Lamp	☆1B				
14	—	Shield case	☆2B				
15	—	Washer	2B				
16	RO6-6002-05	Potentiometer (BALANCE)	☆2B				
17	S33-2041-05	Lever switch	☆2B				
18	X11-1500-11	Control PCB ass'y	☆2B				
19	R10-5003-05	Potentiometer (VOLUME)	☆2B				
20	X11-1500-11	Control PCB ass'y	☆2B				
21	S33-2041-05	Lever switch	☆2B				
22	S33-4019-05	Lever switch (TONE)	☆2B				
23	RO8-3018-05	Potentiometer (TONE)	☆2B				
24	S01-1056-05	Rotary wafer switch (MODE)	☆2B				
25	—	Hardware	☆2B				
26	NO9-0303-05	Screw	☆2A				
			2B				
27	S90-0008-05	Remote switch shaft	☆2B				
28	S90-0009-05	Remote switch shaft	☆2B				
29	—	Cushion	2B				
30 *	E30-	Power cord	2B				
31 *	J41-	Power cord bushing	2B				
32 *	F03-0008-05	AC outlet	2B				
33	E21-0006-25	GND terminal	2B				
34	NO9-0292-05	Screw	2B				
35	—	L shape hardware	2B				
36	E20-0812-05	Binding post ass'y (Speaker)	☆3B				
37	S01-1055-05	Rotary wafer switch	☆3B				
38	—	PC board	☆3B				
39 *	X08-1660.**	Preamp PCB ass'y	☆3B				
40	—	Frame	☆3B				
41	E13-0811-05	Phono jack (8P)	3B				
42	—	Rear panel	☆3B				
43	—	Heat sink	☆3B				
44	—	PC Board	☆3B				
45	V11-5100-10	Diode STV-4H (W)	3B				
46	V01-1107-10	Transistor 2SA1107 (2) (R, Q)	☆3B				
47	V03-2587-10,	Transistor 2SC2587 (2) (R, Q)	☆3B				
48	A01-0346-13	Case	☆1A				
49	N08-0125-05	Dress screw	1A				
50	B19-0201-14	Lighting acryl board	☆1A				
51	—	Meter support hardware	☆1A				
52	B31-0288-05	Power meter	☆1A				
53	B03-0134-04	Dress plate	☆1A				
54 *	S33-	Lever switch (Power)	☆2A				
55	E11-0060-15	Headphone jack	2A				
56	K27-0077-04	Knob	☆2A				
57	D21-0453-03	Shaft	☆2A				
58	B01-0124-04	Panel escutcheon	☆2A				
59	K21-0359-04	Knob (VOLUME)	☆2A				

## PARTS LIST (1)

☆ : New parts  
 FP: Flame-proof  
 RD: Carbon film resistor  
 RC: Carbon composition resistor  
 RW: Wire wound power resistor  
 RN: Metal film resistor  
 RS: Metal oxide film resistor

### TOTAL

Ref. No.	Parts No.	Description	Re- marks
—	A01-0346-13	Case	☆
—	A20-1324-02	Panel ass'y K,P,U,M,S,X,W,L	☆
—	A20-1326-02	Panel ass'y	T ☆
—	A20-1360-02	Panel ass'y	H ☆
—	B01-0124-04	Panel escutcheon × 2	☆
—	B03-0134-04	Dress plate	☆
—	B19-0201-14	Lighting acryl board	☆
—	B30-0167-05	Lamp (8V,0.15A) × 2	☆
—	B31-0288-05	Power meter × 2	☆
—	B46-0055-20	Warranty card	P
—	B46-0060-00	Warranty card	T
—	B46-0061-20	Warranty card	K
—	B46-0062-20	Warranty card	U,H
—	B46-0063-00	Warranty card	U
—	B46-0064-00	Warranty card	X
—	B50-1773-00	Instruction manual K,U,S,X	☆
—	B50-1774-00	Instruction manual	P,M ☆
—	B50-1775-00	Instruction manual	T ☆
—	B50-1804-00	Instruction manual	H ☆
—	B50-1805-00	Instruction manual	W,L ☆
C1,2	C 54-3310-39	Ceramic 0.01μF 25KVDC	W,L,T
C1,2	C90-0145-05	Metal film 0.01μF 125V	K
C1,2	C91-0023-05	Ceramic 0.01μF 250V	U,M,H,S,X
C1,2	C91-0025-05	Metal film 0.01μF 125V	P
C3	C54-3310-39	Ceramic 0.01μF 25KVDC	W,L,T
C4,5	C46-1710-37	Film 0.01μF ±20%	
—	D21-0453-03	Shaft	
—	D22-0031-04	Coupling	
—	D32-0083-04	Switch Stopper U,M,H,S,X,W,L	
—	E03-0008-05	AC outlet × 3 K,P,U,M,H,S,X	
—	E20-0812-05	Binding post ass'y (SPEAKER)	
—	E21-0006-25	GND terminal	
—	E30-0181-05	Power cord	K,P
—	E30-0185-05	Power cord	X
—	E30-0515-05	Power cord	U,M
—	E30-0580-05	Power cord	H,W
—	E30-0585-05	Power cord	L
—	E30-0602-05	Power cord	S,T
—	H01-1831-04	Carton box K,U,M,S,X,W,L	☆
—	H01-1832-04	Carton box	P ☆
—	H01-1833-04	Carton box	H ☆
—	H01-1834-04	Carton box	T ☆
—	H10-1520-02	Polystyrene foamed fixture × 2	☆
—	H20-0448-04	Protection cover	M
—	H20-0453-04	Protection cover K,P,U,H,S,X,W,L,T	
—	H25-0078-04	Polyethylen bag	

Ref. No.	Parts No.	Description	Re- marks
—	J02-0049-14	Foot × 4 P,U,M,H,S,X,W,L,T	
—	J02-0073-04	Foot × 4	K
—	J25-1507-03	PC Board (Speaker terminal)	
—	J41-0024-15	Power cord bushing	S,X,L,T
—	J41-0033-05	Power cord bushing	U,M,H,W
—	J41-0034-05	Power cord bushing	k,P
—	K21-0359-04	Knob (VOLUME)	☆
—	K21-0368-04	Knob × 7	☆
—	K27-0076-04	Knob (lever) × 5	☆
—	K27-0077-04	Knob	☆
—	L01-1661-15	Power transformer	K ☆
—	L01-1662-15	Power transformer	T ☆
—	L01-1665-15	Power transformer	U,M,H,S,X ☆
—	L01-1666-15	Power transformer	W,L ☆
—	L01-1667-05	Power transformer	P ☆
L1,2	L39-0085-05	Phase compensation coil	☆
—	N08-0125-05	Dress screw (Case) × 6	
—	N09-0304-05	Screw (Case)	L
R1,2	R47-1447-95	FP-RS 4.7Ω ±5% 1W	
R3,4	R47-1456-15	FP-RS 560Ω ±5% 1W	
R5,6	R47-1510-05	FP-RS 10Ω ±5% 2W	
R7~14	R43-1210-05	FP-RD 10Ω ±5% 1/4W	
S1	S33-2042-05	Lever switch (Power)	W,L,T ☆
S1	S33-2046-05	Lever switch (Power)	K,P ☆
S1	S33-2047-05	Lever switch (Power)	U,M,H,S,X ☆
S2,3	S31-2001-05	Slide switch (Power voltage selector)	U,M,H,S,X,W,L
S4	S01-1055-05	Rotary wafer switch (Speaker selector)	
—	S90-0010-05	Remote Wire (Input selector)	
—	S90-0011-05	Remote Wire (Tape)	
Q1	V01-1107-10	Transistor 2SA1107 (2) (R,Q)	
Q2	V03-2587-10	Transistor 2SC2587 (2) (R,Q)	
Q3	V01-1107-10	Transistor 2SA1107 (2) (R,Q)	
Q4	V03-2587-10	Transistor 2SC2587 (2) (R,Q)	
Q5	V01-1107-10	Transistor 2SA1107 (2) (R,Q)	
Q6	V03-2587-10	Transistor 2SC2587 (2) (R,Q)	
Q7	V01-1107-10	Transistor 2SA1107 (2) (R,Q)	
Q8	V03-2587-10	Transistor 2SC2587 (2) (R,Q)	
D1,2	V11-5100-10	Diode STV-4H (W)	
—	X07-1640-01	Power Amp. PCB ass'y	U,M,H,S,X ☆
—	X07-1640-10	Power Amp. PCB ass'y	K,P ☆
—	X07-1640-61	Power Amp. PCB ass'y	W,L,T ☆
—	X08-1660-10	Preamp. PCB ass'y	K,P,U,M,H,S,X ☆
—	X08-1660-61	Preamp. PCB ass'y	W,L,T ☆
—	X11-1500-11	Control PCB ass'y	☆

PART (3)

POWER AMP. PCB ASS'Y (X07-1640-01,-10,-61)

Ref. No.	Parts No.	Description	Re ma
C1,2	C90-0395-05	Electrolytic 10 $\mu$ F 25WV	
C3~6	C24-1410-61	Electrolytic 10 $\mu$ F 25WV	
C11,12	C46-1747-36	Mylar 0.047 $\mu$ F $\pm$ 10%	
C13,14	C24-1047-61	Electrolytic 47 $\mu$ F 10WV	
C15~18	C25-1747-47	Electrolytic 0.47 $\mu$ F 50WV	
C19,20	C90-0379-05	Electrolytic 10000 $\mu$ F 63WV	☆
C23~26	C54-2710-39	Ceramic 0.01 $\mu$ F +100%—0%	
C30	C90-0394-05	NP-Electrolytic 47 $\mu$ F 25WV	☆
C31,32	C24-1210-61	Electrolytic 10 $\mu$ F 16WV	
C33	C25-1210-77	Electrolytic 100 $\mu$ F 16WV	
C34,35	C25-6522-57	Electrolytic 2.2 $\mu$ F 35WV	
F1~4	F05-5021-05	Fuse 5A $\times$ 4 K,P,U,M,H,S,X,L,T	
F1~4	F05-5024-05	Fuse 5A $\times$ 4 W	
—	J13-0058-05	Fuse holder $\times$ 2	☆
VR1,2	R12-0052-05	Trimming Potentiometer 500 $\Omega$ B $\times$ 2 (Power meter adj.)	
VR3,4	R12-0047-05	Trimming Potentiometer 100 $\Omega$ B $\times$ 2 (Bias)	
R1~4	R43-1227-05	FP-RD 27 $\Omega$ $\pm$ 5% 1/4W	
R5,6	R43-1236-05	FP-RD 36 $\Omega$ $\pm$ 5% 1/4W	
R19,20	R43-1247-05	FR-RD 47 $\Omega$ $\pm$ 5% 1/4W	
R21~28	R92-0175-05	Cement 0.47 $\Omega$ 3W	
R29~32	R47-1610-05	RS 10 $\Omega$ $\pm$ 5% 5W	
R43	R47-5447-25	RS 4.7k $\Omega$ $\pm$ 5% 1W	
R46	R47-1568-15	RS 680 $\Omega$ $\pm$ 5% 2W	
R48,49	R47-5527-25	RS 2.7k $\Omega$ $\pm$ 5% 2W	
R60~62	R47-1539-05	RS 39 $\Omega$ $\pm$ 5% 2W	
RL1	S51-4034-05	Relay	
Q1,2	V03-0468-05	Transistor 2SC1913 (Q,R)	
Q3,4	V01-0188-05	Transistor 2SA913 (Q,R)	
Q5,6	V03-0270-05	Transistor 2SC945 (R,Q)	
Q7~10	V01-0733-30	Transistor 2SA733 (A) (R,Q)	
Q11,12	V03-0270-05	Transistor 2SC945 (R,Q)	
D1~4	V11-0273-05	Diode 1S2076A	
D5,6	V11-0271-05	Diode 1S2076	
D7,8	V11-0295-05	Diode W06B	
D9	V11-4102-10	Zener Diode WZ-050	
D11~18	V11-0465-05	Diode GP25D or	
	V11-2100-10	Diode U05C (S)	
IC1	V30-0291-10	IC HA12002	
IC2	V30-0292-10	IC TA7318P	

3/20/74

## CIRCUIT DESCRIPTION (2)

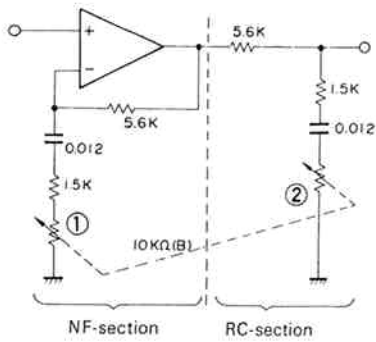


Fig. 3-2 Equivalent circuit of TREBLE section

As shown in Figure 4-2, the NF-section produces high gain in the higher frequency range, which is cancelled by the gain produced by the RC-section. Thus, a completely flat frequency response in the TREBLE range can be obtained as shown in Figure 4-3.

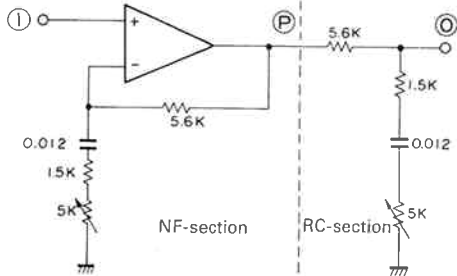
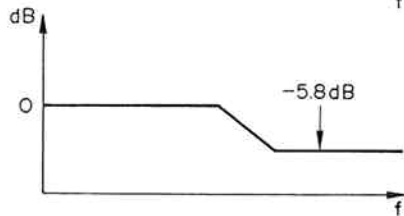
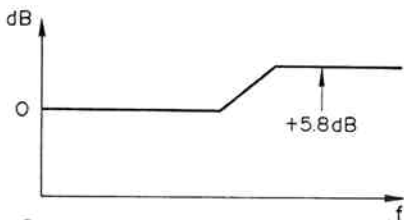
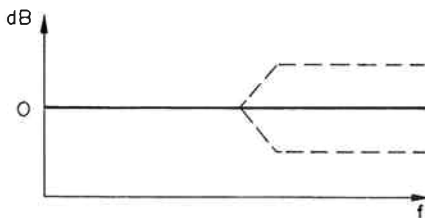


Fig. 4-1 Equivalent circuit for flat TREBLE



4-2 Frequency response of NF-section (above) and RC-section (below)



4-3 Overall frequency characteristics of flat TREBLE control

Figures 5-1 to 5-3 show the equivalent circuit and performance the TREBLE control when it is set to a lower position. In this case, the NF-section increases the gain by a smaller amount in the higher frequency range, whereas the RC-section decreases the gain by a greater amount as shown in Figure 5-2. Thus, decreased frequency response in the TREBLE range can be obtained as shown in Figure 5-3.

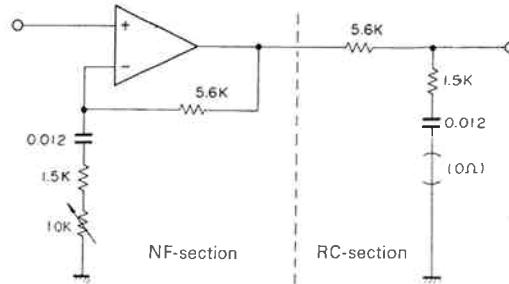


Fig. 5-1 Equivalent circuit for lower TREBLE control setting

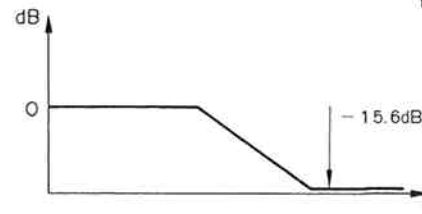
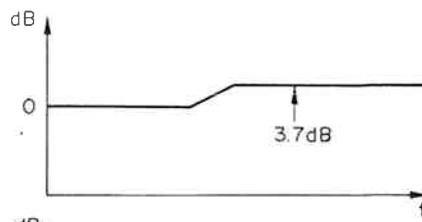


Fig. 5-2 Frequency responses of NF-section (above) and RC-section (below)

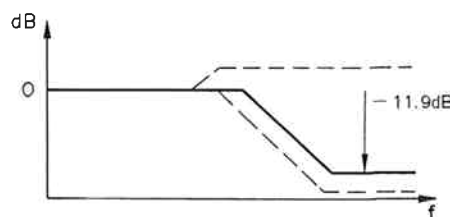


Fig. 5-3 Overall frequency response with lower TREBLE setting

In the opposite way, when the TREBLE control is boosted, the NF-section increases the gain by a larger amount in the higher frequency range, whereas the RC-section decreases the gain by a smaller amount, obtaining the increased frequency response in the TREBLE range as shown in Figures 6-2 and 6-3.

CIRCUIT DESCRIPTION (3)

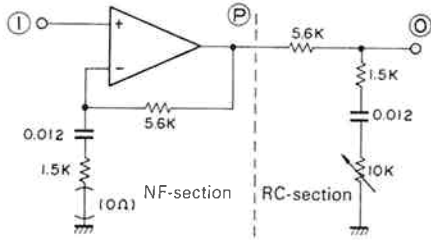


Fig. 6-1 Equivalent circuit for boosted TREBLE control

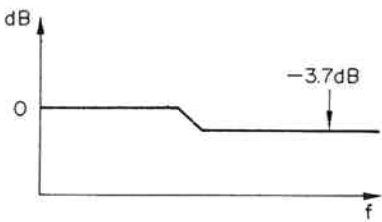
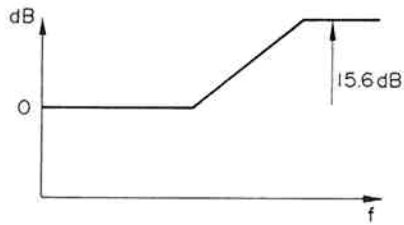


Fig. 6-2 Frequency responses of NF-section (above) and RC-section (below)

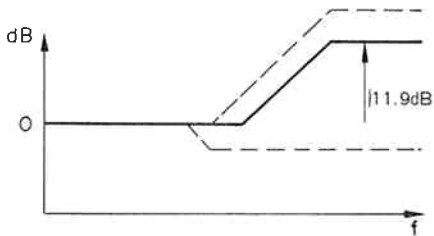


Fig. 6-3 Overall frequency response with boosted TREBLE control

BASS CONTROL

Figure 7-1 shows the BASS section of the tone control circuit, and Figure 7-2 is the equivalent circuit which explains its operation. The 10 kΩ VR is divided into two VRs ① and ②, where ① + ② = 10 kΩ.

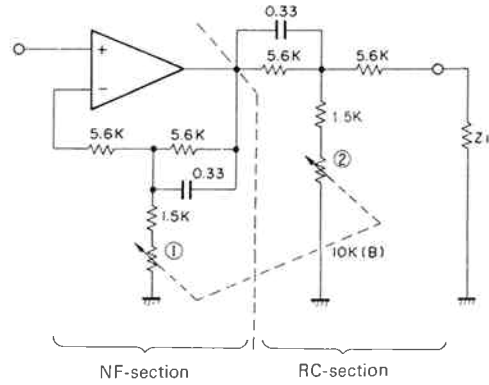
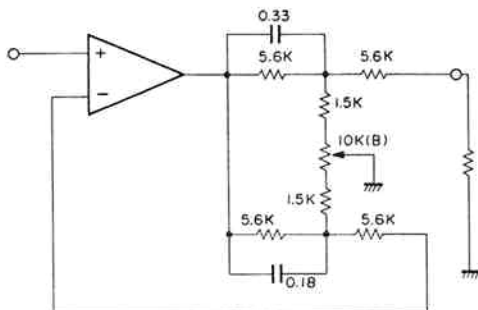


Fig. 7 Tone control circuit (BASS section)

Figure 8-1 is an equivalent circuit showing conditions when the BASS control is set to its mid-range (zero) position. The NF-section increases the gain and the RC-section decreases the gain in the BASS range, obtaining the completely flat frequency response as shown in Figures 8-2 and 8-3.

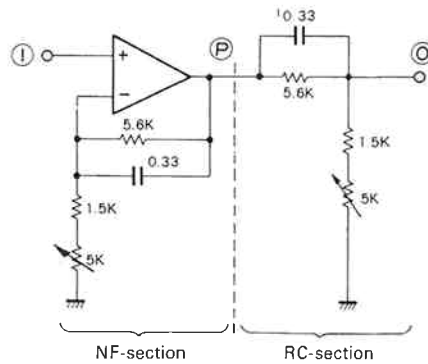


Fig. 8-1 Equivalent circuit for flat BASS

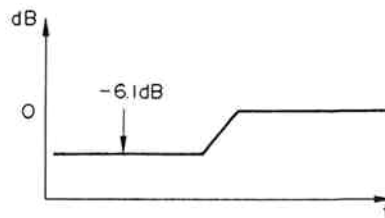
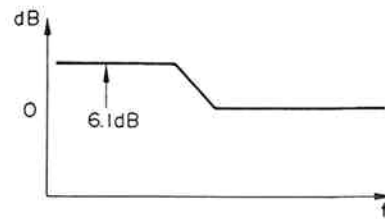
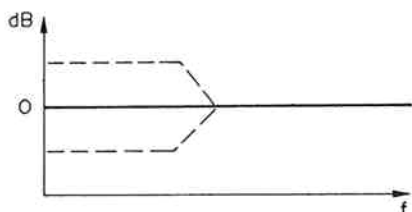
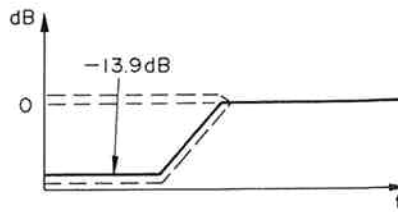


Fig. 8-2 Frequency responses of NF-section (above) and RC-section (below)

## CIRCUIT DESCRIPTION (4)



**Fig. 8-3 Overall frequency response with flat BASS control**

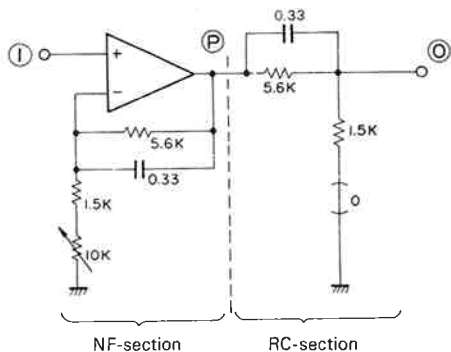


**Fig. 9-3 Overall frequency response of decreased BASS control**

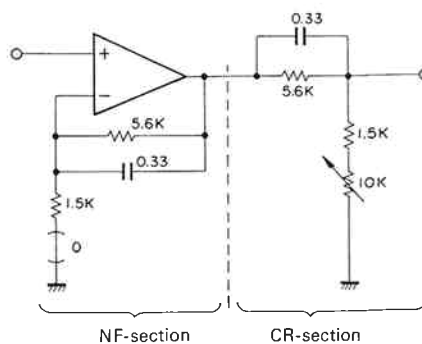
The low range level is decreased when VR1 is larger than 5 kΩ, and the level reaches its minimum at VR1 = 10K and VR2 = 0 as shown in Figure 9-1.

In this case, the low range is not the increased by greatly by the NF circuit but it is decreased greatly by the CR circuit as shown in Figure 9-2, resulting in decreased overall response at the lower range as shown in Figure 9-3.

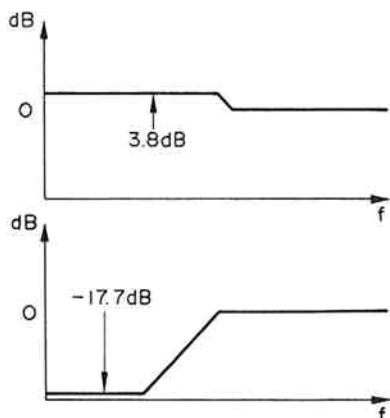
The low range level is increased when VR2 (10 kΩ) is larger than 5 kΩ and VR1 is low. The level reaches its maximum at VR1 = 0 and VR2 = 10 kΩ as shown in Figure 10-1. The low range is greatly increased by the NF circuit but is not increased so much by the CR circuit as shown in Figure 10-2, resulting in the increased overall response at the lower range as shown in Figure 10-3.



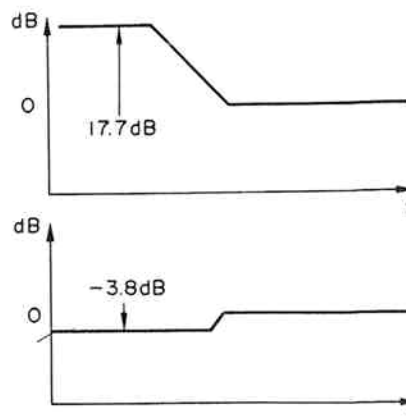
**Fig. 9-1 Equivalent circuit for decreased BASS control**



**Fig. 10-1 Equivalent circuit for boosted BASS control**

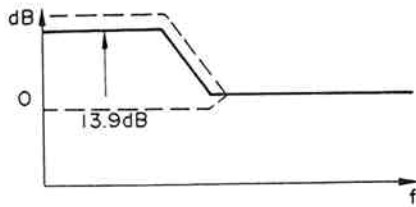


**Fig. 9-2 Frequency responses of NF-section (above) and RC-section (below)**



**Fig. 10-2 Frequency responses of NF-section (above) and RC-section (below)**

## CIRCUIT DESCRIPTION (5)



**Fig. 10-3 Overall frequency response with boosted BASS control**

### PROTECTION CIRCUIT (IC: HA12002)

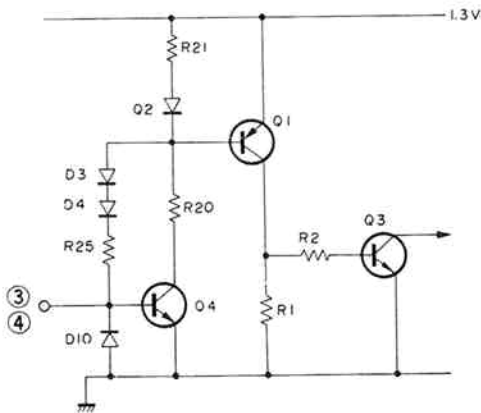
This integrated circuit protects the loudspeakers and power amplifier. The IC consists of a zero-potential detector, overheating detector, line voltage detector, and relay driver; the KA801 uses only the zero-potential and line voltage detectors.

#### ZERO-POTENTIAL DETECTOR

Pin 3 or Pin 4 is used to detect zero-potential where Q4, Q1 and Q3 are all cut-off.

When a voltage higher than +0.5V is applied to pin 3, Q4 turns ON and then Q1 and Q3 also turn ON. Diodes D3, D4 and D10 remain OFF.

When a voltage lower than -0.3V is applied to pin 3, diodes D3 and D4 conduct and the current is supplied to the base of Q1, turning Q1 and then Q3 ON.



**Fig. 11 Zero-potential detector**

#### OVERLOAD DETECTOR

The overload signal is applied to Pin 6. A pair of transistors, Q7 and Q8, forms a flip-flop, and the collector of the Q7 is connected to the base of inverter Q6 through R3.

Normally, the base of Q7 is supplied with a higher voltage than that supplied to the base of Q8 (the base voltage of Q7 is supplied from the anode of D8, whereas the base voltage of Q8 is supplied from the cathode of D8), so Q7 is ON, and Q8 is OFF. Thus, Q6 is OFF.

When the positive overload signal is applied to Pin 6, Q8 turns ON and the collector voltage drops. The base voltage of Q7 also drops because of its connection to the collection of Q8 through R5, so Q7 is turned OFF. The collector voltage of Q7 rises, which raises the base voltage of Q7 through R3, and Q8 remains ON.

Diode D0, connected to Pin 6, cuts the negative input voltage applied to the base of Q8, so that Q8 is prevented from turning OFF.

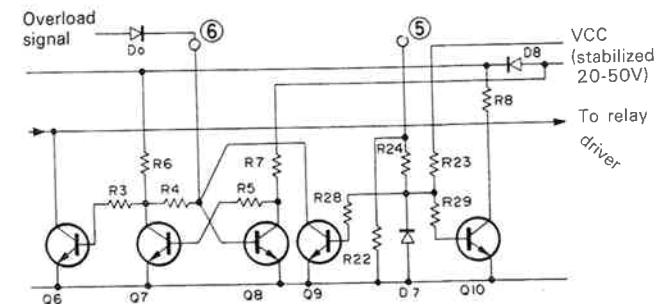
Accordingly, once a positive overload signal is applied to the circuit, the circuit condition is locked until the power is turned OFF.

#### LINE VOLTAGE DETECTOR

The time constant of the ripple filter consisting of R42 and C32 is set to a low value so that the voltage at Pin 5 drops to a negative level immediately after the power is turned on and is set to Zero immediately after the power is turned off (resulting from rapid discharge).

The negative voltage from Pin 5 is applied to the cathode of D7 through R24 together with another positive power voltage which is applied through R23. The cathode voltage of D7 is normally about -0.5V, so Q9 and Q10 are kept OFF.

When the line voltage is switched OFF, the voltage at Pin 5 falls to 0V quickly, and only the remaining positive power voltage is applied to the cathode of D7 through R23. Thus, Q9 and Q10 are turned ON.



**Fig. 12 Overload detector/Line voltage detector**

## CIRCUIT DESCRIPTION (6)

### NOR GATE AND POWER-ON POWER CIRCUIT

Transistors Q3, Q6 and Q10 are provided with common connected collectors and emitters. The collector voltage in the normal state is about 0.6V. (Here, we call this voltage level "H".)

If a voltage higher than 0.6V is applied to the base of Q3, Q3 turns ON, and the collector voltage falls to about 0.1V. (We call this voltage level "L".)

The same result is obtained when level "H" is input to the base of Q6 or Q10 instead of Q3, and the output becomes "L".

This kind of circuit with multiple input terminals and a single output terminal, the output being "H" when all inputs are "L", and the output being "L" when at least one input is "H", is called a NOR gate. The NOR gate is generally expressed with a logical symbol, and the relation between multiple inputs and single output is presented in the "truth table", shown in Figure 13.

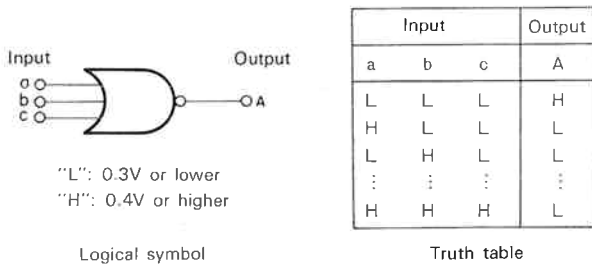


Fig. 13 Logical symbol and truth table of NOR gate

In Figure 14, the positive feedback is applied from the emitter of Q13 to the base of Q11 through R19 and the diode, in order to speed up and also stabilize the operation of Q11, Q12 and Q13.

For the power-ON muting circuit, resistors Rs and Rx and capacitor Cs are connected to Pin 8. Among the six transistors only Q13 is delayed in turning ON, since increasing the base voltage takes time as Cs is charged through Rs.

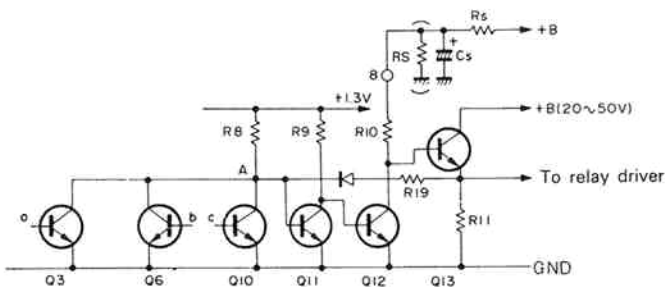


Fig. 14 NOR gate and power-ON muting circuit

### RELAY DRIVER AND VOLTAGE STABILIZER

The DC power voltage supplied to the whose circuit except the relay driver is stabilized using Q17, R15 and Z1, and further made accurate by D1 and D2 to become +1.3V.

The output of Q13 in Figure 14 is connected through R13 to emitter follower Q15, which drives Q16.

Pin 1 is the output terminal of the relay driver.

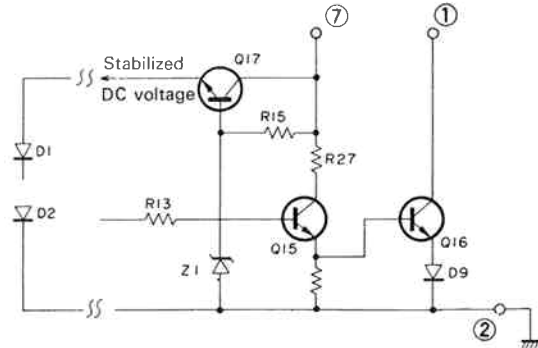
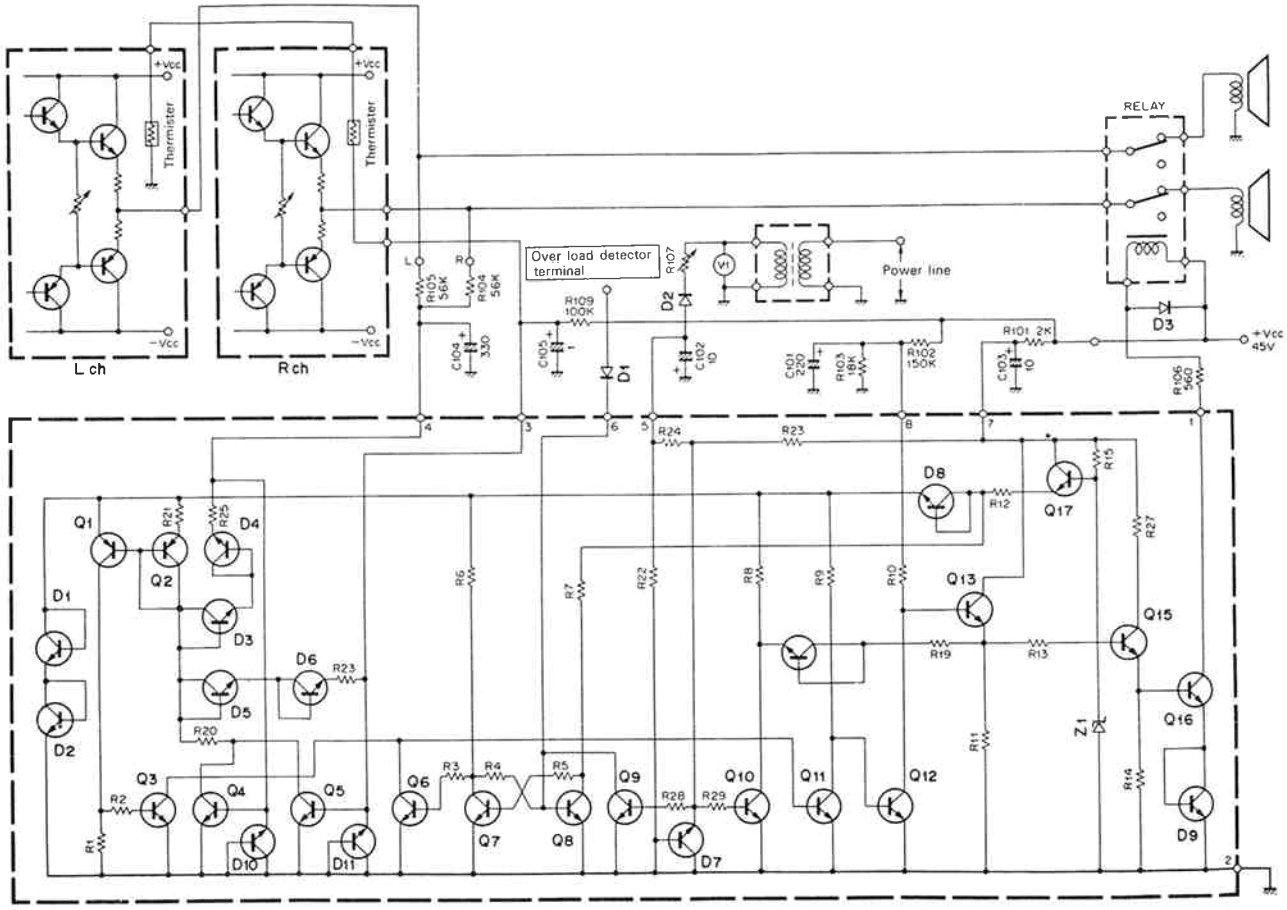


Fig. 15 Relay driver and power stabilizer



**CIRCUIT DESCRIPTION (7)**



Pin 3 and Pin 4 have same characteristics. When an external circuit consisting of R104, R105 and C104 is connected to either pin, it detects the mid-point voltage and when an external circuit consisting of the thermistors and C105 is connected, it detects the temperature (of the power transistors).

< HA12002 equivalent circuit >

## ADJUSTMENT

### PREAMP OFFSET VOLTAGE ADJUSTMENT

1. Decline the rear panel.
2. Connect a dc voltmeter to the adjusting points 7 and 8 (9 and 10) of the preamp pc board ass'y (X08-1660-10).
3. Adjust the trimming pot VR1 (VR2), as shown in figure 1, for 0V reading of the dc voltmeter.

### POWER METER LEVEL ADJUSTMENT

1. Connect an AG and dummy load to Aux jack and speaker terminal respectively.
2. Connect an AC voltmeter across the dummy load.
3. Adjust the trimming pot VR3 (VR4), when the AC voltmeter indicating, 28.28V, for 100W reading of power meter.

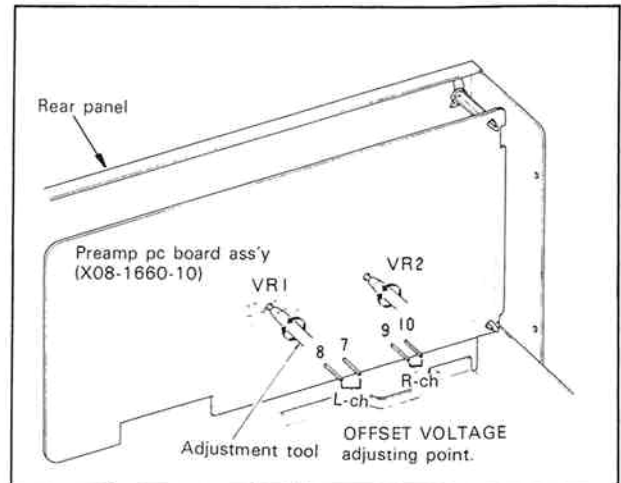
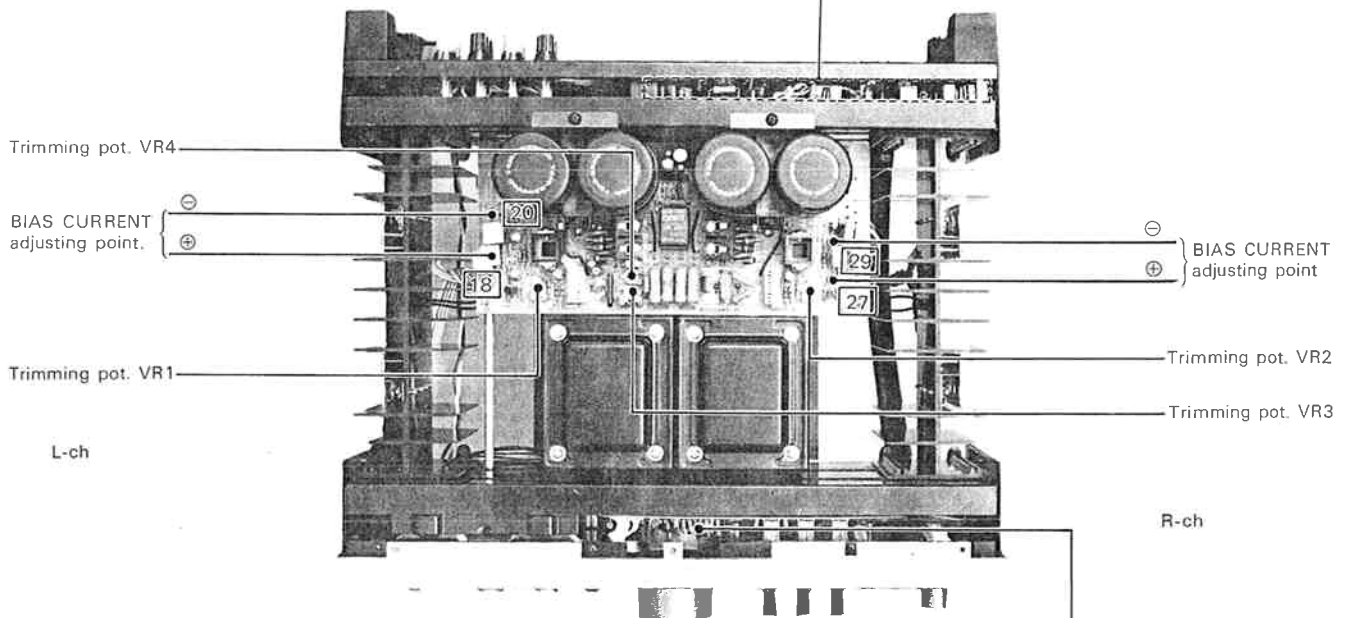


Fig. 1. Preamp offset voltage adjustment.



### POWER AMP OFFSET VOLTAGE ADJUSTMENT

1. Remove the front panel.
2. Connect the dc voltmeter between the positive and negative speaker terminals.
3. Adjust the trimming pot VR5 (VR6), as shown in figure 2, for a 0V reading of the dc voltmeter.

### BIAS CURRENT ADJUSTMENT

1. Turn the volume control knob fully counter clockwise.
2. Connect the dc voltmeter between the adjusting points 18 and 20 (27 and 29) of power amp pc board ass'y (X07-1640-10).
3. Adjust the BIAS CURRENT trimming pot VR1 (VR2), for an 18 mV reading of the voltmeter.

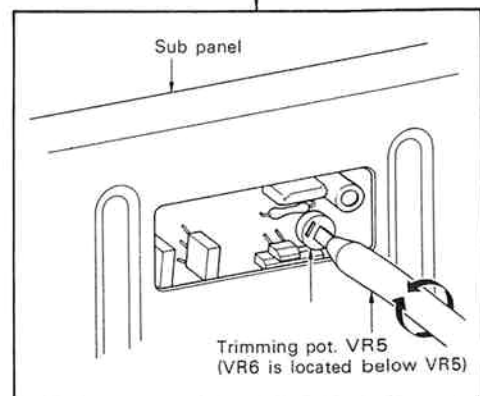


Fig. 2. Power amp offset voltage adjustment.

## RÉGLAGES

### RÉGLAGE DE LA TENSION DE DECALAGE (OFFSET) EN SECTION PREAMPLI

1. Pencher le panneau arrière en dehors.
2. Brancher le voltmètre de c.c. aux points d'alignement, 7 et 8 (9 et 10), sur la plaque circuit imprimé du préampli (X08-1660-10), comme le montre le figure 1.
3. Régler le potentiomètre ajustable VR1 (VR2) de façon à ce que le voltmètre de c.c. indique 0V.

### RÉGLAGE DU VU MÈTRE

1. Relier un AC (générateur de signaux audio) sur les prises Aux et une fausse charge (Resistance) sur les bornes de haut-parleur.
2. Relier un voltmètre aux deux extrémités de la résistance (ou aux borne de sortie + et -).
3. Régler le potentiomètre ajustable VR3 (VR4) en sorte que le VU mètre indique 100W lorsque le voltmètre indique 28, 28V.

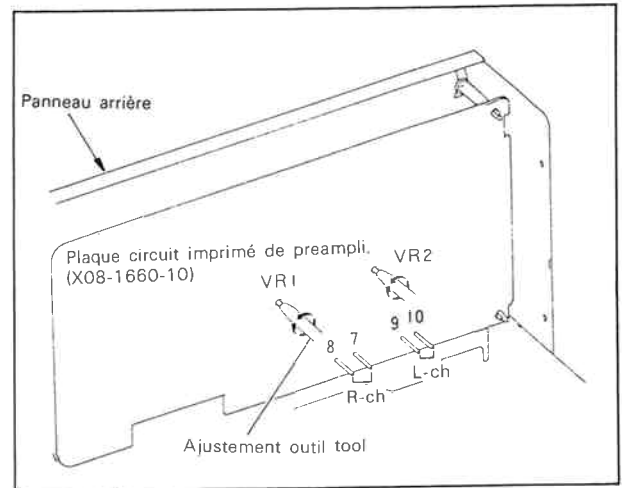
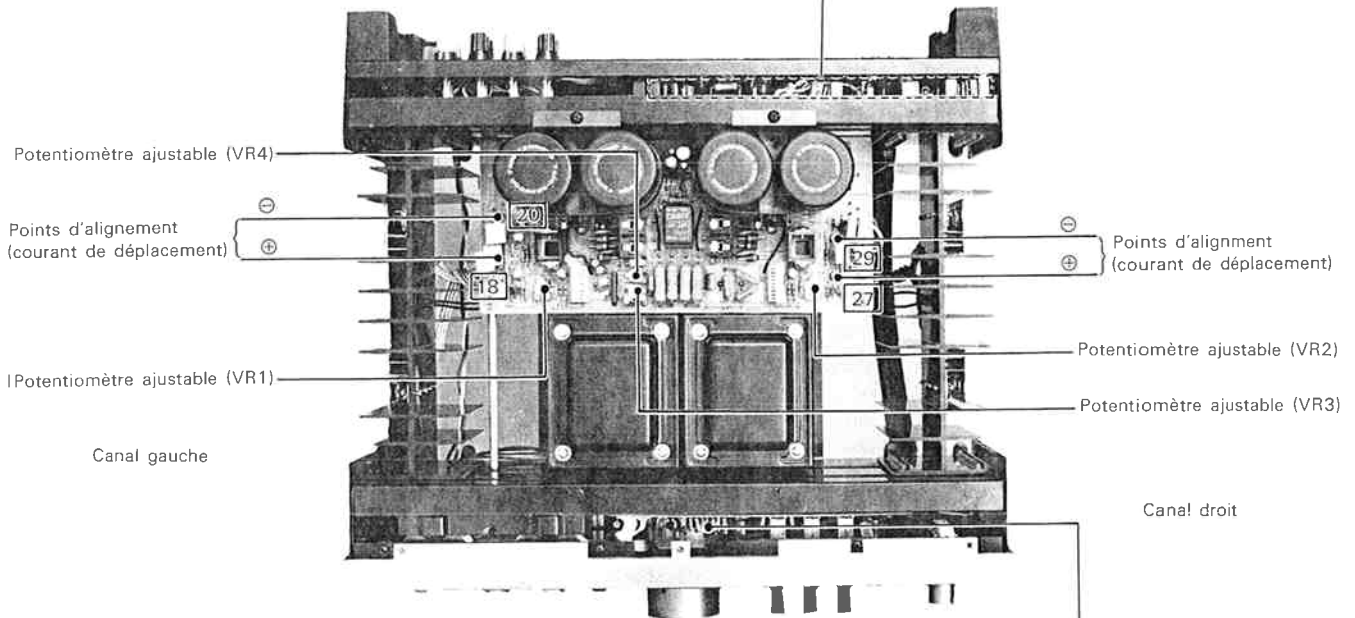


Fig. 1. Réglage de la tension de décalage (offset) en section préampli.



### RÉGLAGE DE LA TENSION DE DECALAGE (OFFSET)

1. Démontez le panneau avant.
2. Branchez le voltmètre de c.c. aux bornes de sortie + et -.
3. Régler le potentiomètre ajustable VR5 (VR6) pour que la tension de sortie soit nulle, comme le montre ce figure 2.

### RÉGLAGE DU COURANT DE DEPLACEMENT

1. Tourner le bouton de commande de volume à fond dans le sens inversé de celui des aiguilles d'une montre.
2. Branchez le voltmètre de c.c. aux points d'alignement, 18 et 20 (27 et 29), sur la plaque circuit imprimé d'ampli de puissance (X07-1640-10).
3. Régler le potentiomètre ajustable VR1 (VR2) de façon à ce que le voltmètre de c.c. indique 18 mV.

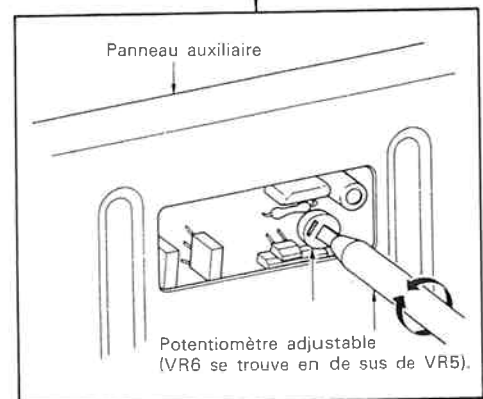


Fig. 2. Réglage de la tension de décalage (offset) en section ampli de puissance.

## ABGLEICH

### OFFSET-SPANNUNG DES VORVERSTÄRKERS

1. Die Hinterseiteplatte neigen.
2. Den Gleichspannungsmesser zwischen der Regulierungs-Punkte 7 (9) und 8 (10) des Vorverstärkers anschließen. (Abb. 1)
3. Den halbeingebetteten Widerstand VR1 (VR2) so regulieren, daß die Gleichspannungsmesser-Ablesung 0V ist.

### PEGELEINSTELLUNG DES STROMMESSERS (POWER METER)

1. Einen AG (NF-Signalgenerator) an die AUX-Buchsen und eine künstliche Last (8Ω, 100W oder mehr) an die Lautsprecher-Anschlüsse anschließen.
2. Einen Wechselstrom-Voltmeter über die künstliche Last anschliessen.
3. Den AG auf 1 kHz einstellen.
4. Die Lautstärke regler (oder den AG-Ausgang) so einstellen, daß der Voltmeter 28, 28V anzeigt.
5. Das Trimm-Potentiometer VR3 (VR4) so einstellen, das der Strommesser 100W anzeigt.

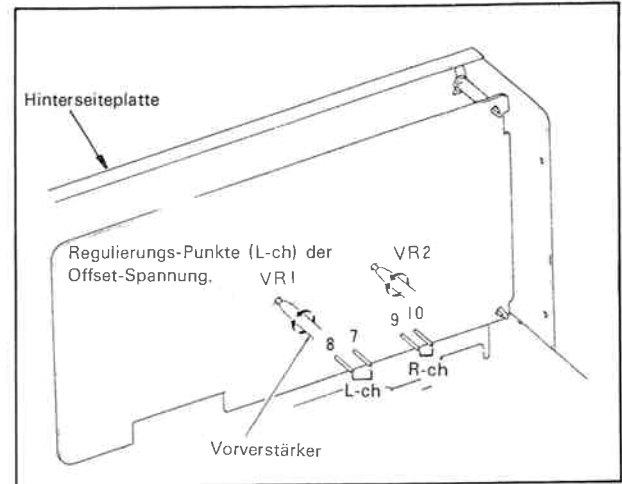
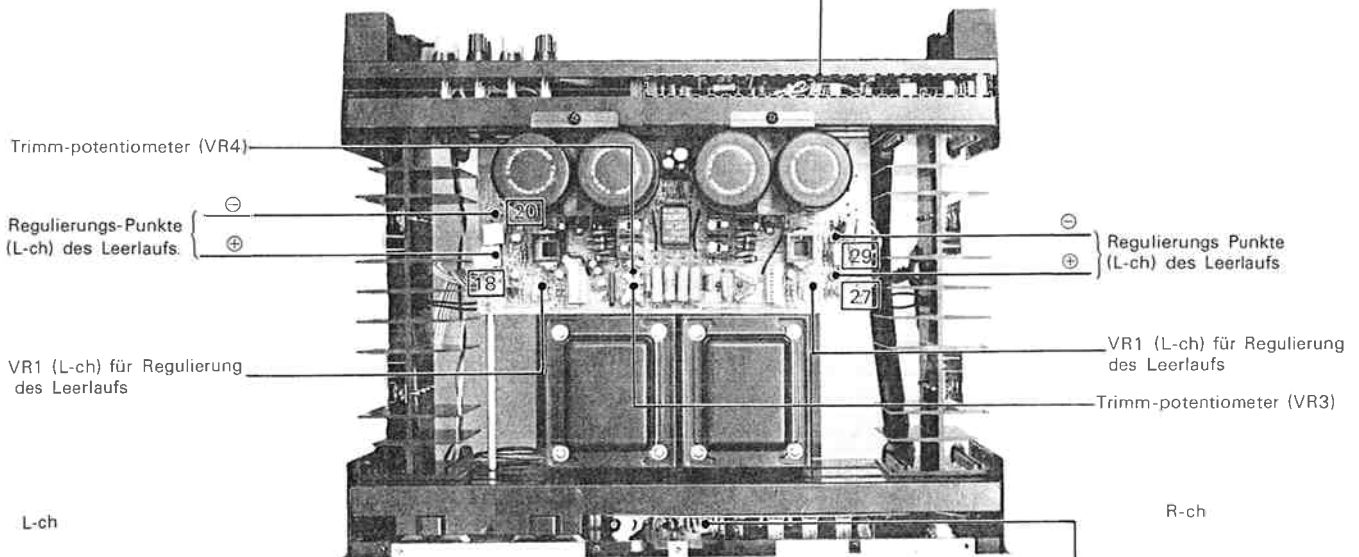


Fig. 2. Offset-spannung der leistungsverstärker



### OFFSET-SPANNUNG DER END-VERSTÄRKER

1. Die Platte entfernen.
2. Den Gleichspannungsmesser zwischen der klemme 24 (23) der Leistungsverstärker und der Erde anschließen. (Abb. 2)
3. Die Regelstange durch das Unterplattenloch einführen und den halbeingebetteten Widerstand VR5 (VR6) so regulieren, daß die Gleichspannungsmesser-Ablesung 0V ist.

### LEERLAUFS

1. Den Lautstärkereger (VOLUME) drehen um die Leistungsverstärker-Aufnahme auf Null zu reduzieren.
2. Den Gleichspannungsmesser zwischen der Regulierungs-Punkte ⊕ und ⊖ der Leistungsverstärker anschließen.
3. Den halbeingebetteten Widerstand VR1 (VR2) der Leistungsverstärker so regulieren, daß die Gleichspannungsmesser-Ablesung 18 mV ist.

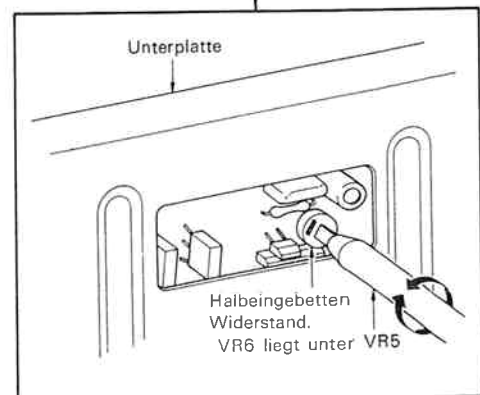
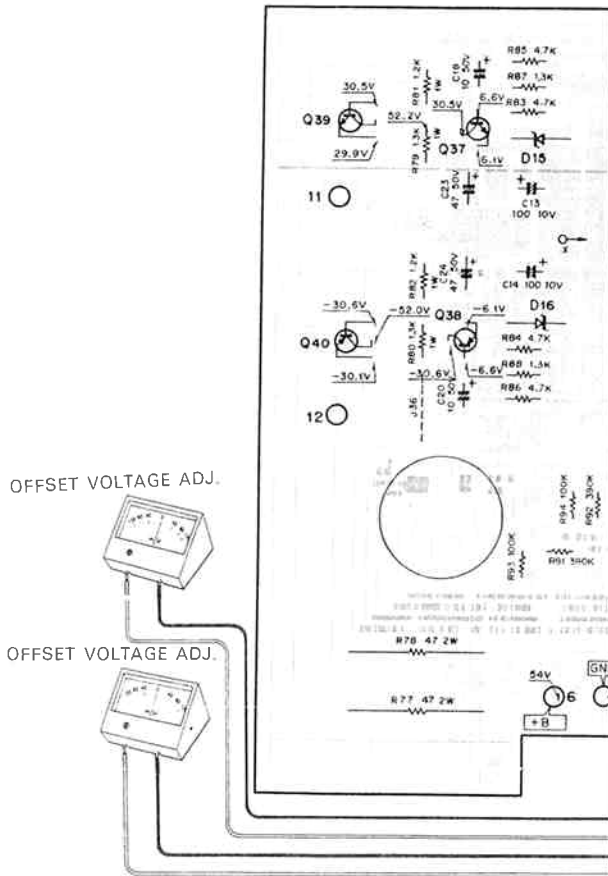


Fig. 2. Offset-spannung der leistungsverstärker.

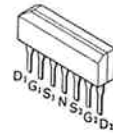
## Preamp. (X08-1660-10) (Foil Side)



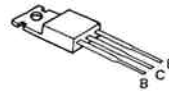
- 2SA733A
- 2SA954
- 2SA1023
- 2SC945
- 2SC2003
- 2SC2378



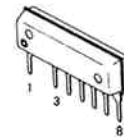
2SK150A



- 2SB507V
- 2SD313V



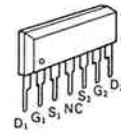
HA1457



- 2SA899
- 2SC1904



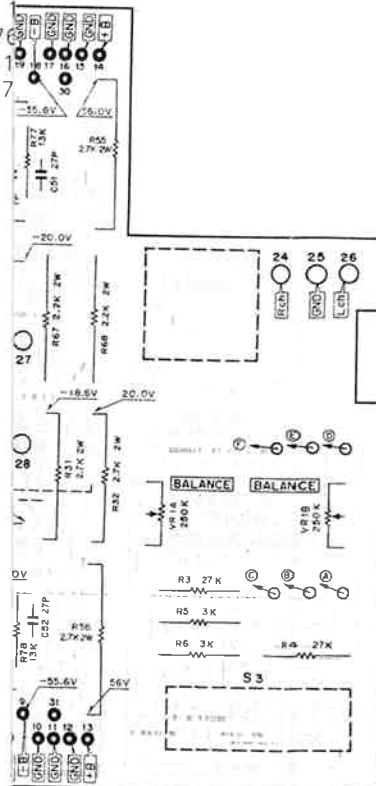
2SK111



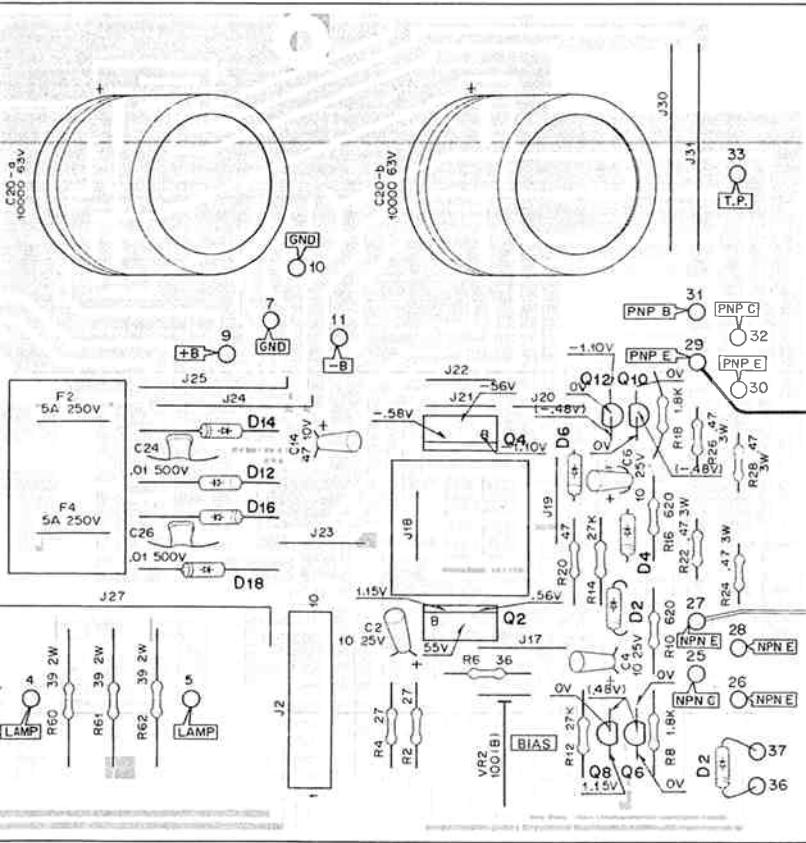
- 2SC2559
- 2SC2291



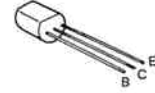
- Q13~16, 21~24: 2SA733A (R, Q)
- Q17~20, 25, 26: 2SC945 (R, Q)
- Q27, 28: 2SA1023 (R, Q)
- Q29, 30: 2SC2378 (R, Q)
- Q31, 32, 35~37: 2SC2003 (M, L)
- Q33, 34, 38: 2SA954 (M, L)
- Q39: 2SD313
- Q40: 2SB507
- Q41, 42: 2SK111
- D5~12: 1S2070
- D15, 16: WZ-061
- D17, 18: WZ-157



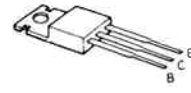
R SUBSTITUTIONS



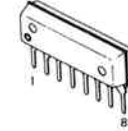
2SA733A  
2SC945



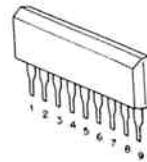
2SA913  
2SC1913



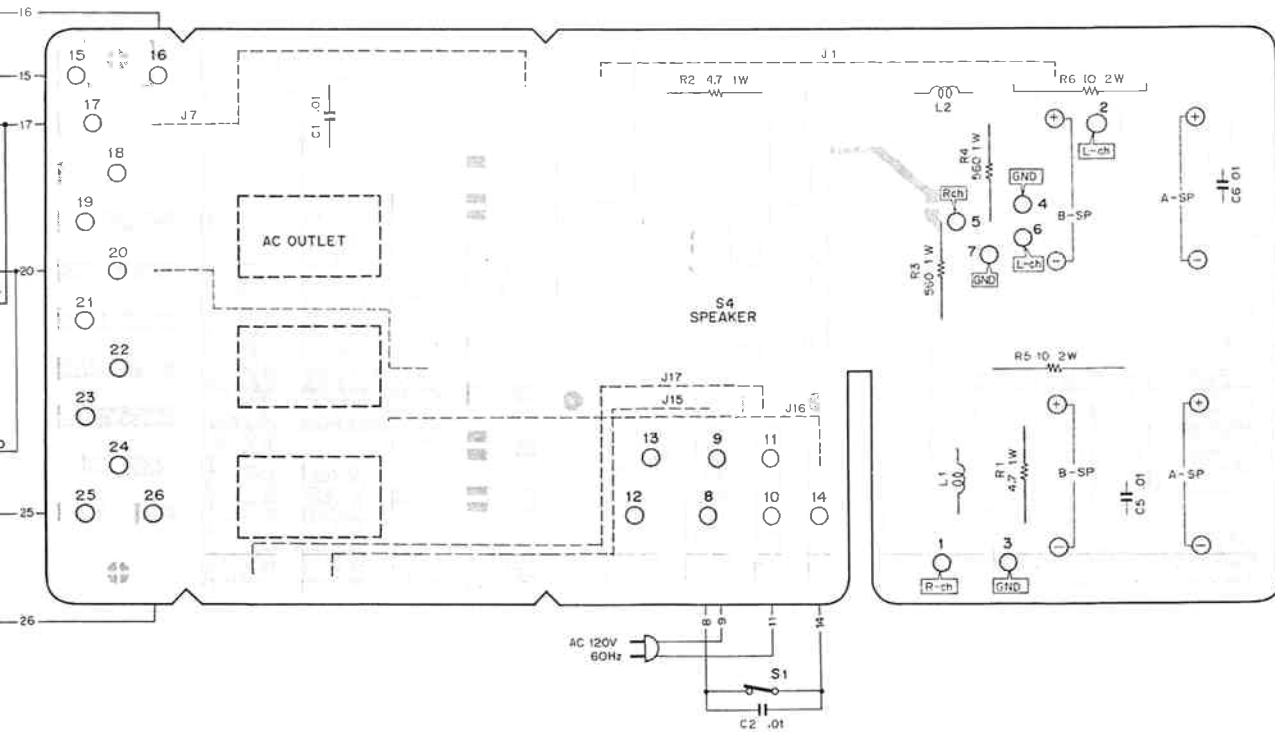
HA12002



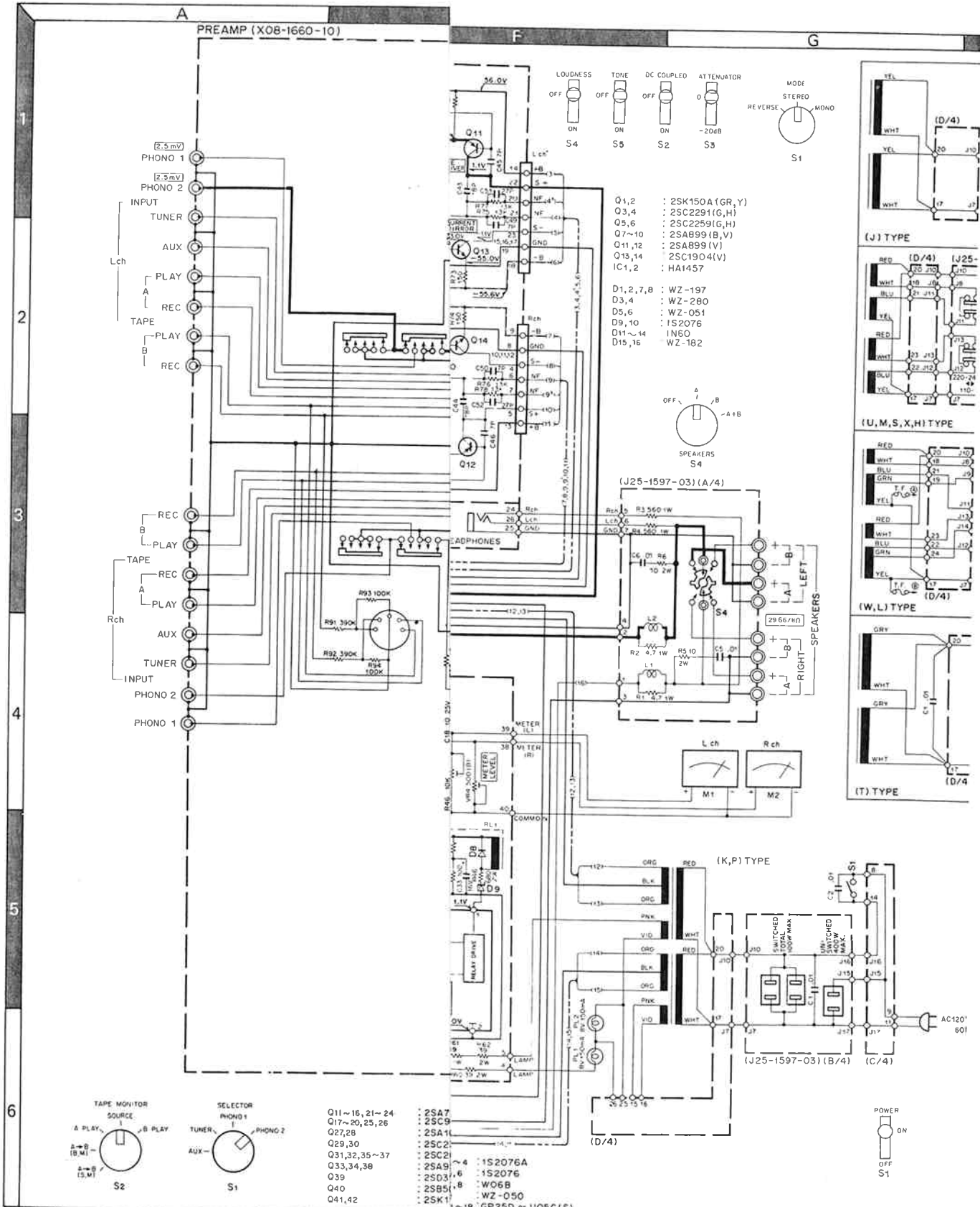
TA7318P



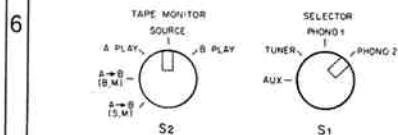
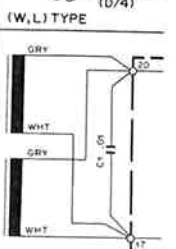
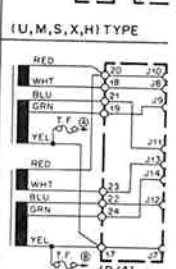
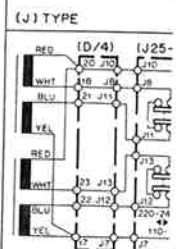
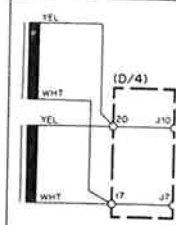
7-03 (Foil Side)



# KENWOOD AMPLIFIER

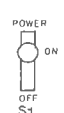


- Q1,2 : 2SK150A (GR, Y)
- Q3,4 : 2SC2291 (G, H)
- Q5,6 : 2SC2259 (G, H)
- Q7~10 : 2SA899 (B, V)
- Q11,12 : 2SA899 (V)
- Q13,14 : 2SC1904 (V)
- IC1,2 : HA1457
- D1,2,7,8 : WZ-197
- D3,4 : WZ-280
- D5,6 : WZ-051
- D9,10 : 1S2076
- D11~14 : 1N50
- D15,16 : WZ-182



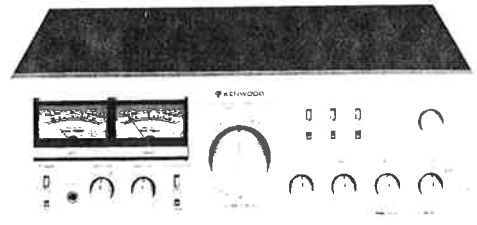
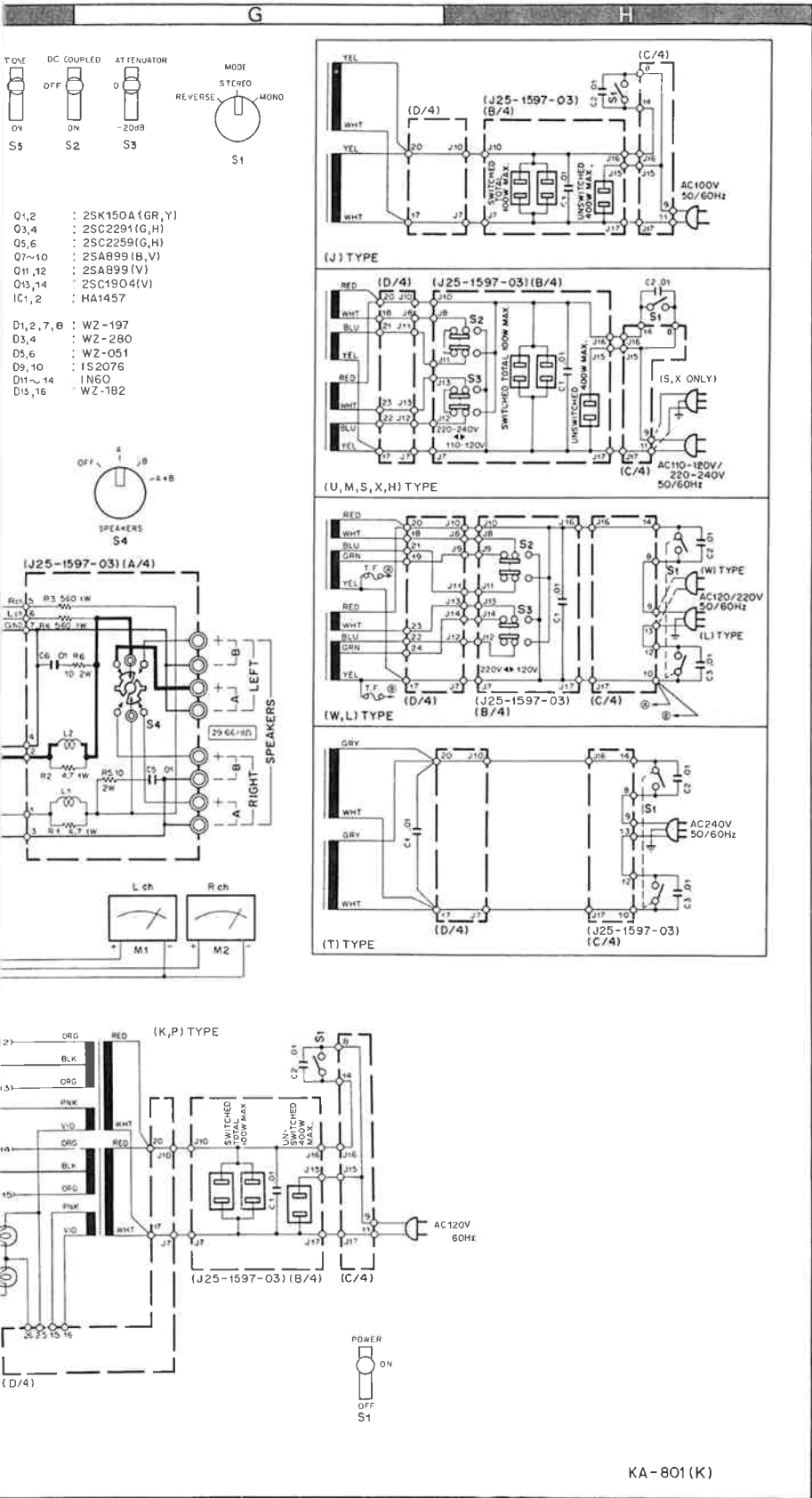
- Q11~16, 21~24 : 2SA7
- Q17~20, 25, 26 : 2SC9
- Q27, 28 : 2SA11
- Q29, 30 : 2SC2
- Q31, 32, 35~37 : 2SC2
- Q33, 34, 38 : 2SA9
- Q39 : 2SD3
- Q40 : 2SB5
- Q41, 42 : 2SK1

- 2SA1107 (2)
- 2SC2587 (2)
- 2SA733A
- 2SA777
- 2SA872
- 2SA921
- 2SA954
- 2SA992
- 2SA1023
- 2SC945
- 2SC1509
- 2SC1775
- 2SC1845
- 2SC1980
- 2SC2003
- 2SC2378
- 2SA850
- 2SC1735
- 2SA839
- 2SB
- 2SA913
- 2SC
- 2SD313V
- 2SC



DC voltage  
anal.

# (KA-8011) KA-801



## SPECIFICATIONS

- Power Output**  
 110 watts\* per channel minimum RMS, both channels driven, at 8Ω from 20 Hz to 20,000 Hz with no more than 0.015% total harmonic distortion.
- Both Channels Driven** ..... 115 + 115 watts 8Ω at 1,000 Hz  
 130 + 130 watts 4Ω at 1,000 Hz
- Total Harmonic Distortion (20 Hz to 20,000 Hz):**  
 AUX Input to  
 SPEAKER Output..... 0.015% at rated power into 8Ω  
 0.008% at 1/2 rated power into 8Ω
- PHONO Input to**  
 SPEAKER Output..... 0.015% at rated power with VOLUME -20 dB
- Intermodulation Distortion** .. 0.003% at rated power into 8Ω (60 Hz: 7 kHz = 4 : 1)
- Damping Factor** ..... 100, DC ~ 20,000 Hz into 8Ω
- Transient Response:**  
 Rise Time ..... 0.8 μs  
 Slew Rate ..... ±150 V/μs
- Power Bandwidth**..... 5 Hz to 70,000 Hz at 0.03% T.H.D.
- Frequency Response:**  
 (DC COUPLED at ON)..... DC to 400 kHz, -3 dB  
 (DC COUPLED at OFF) .... 18 Hz to 400 kHz, -3 dB
- Speaker Impedance**..... Accept 4Ω to 16Ω
- Input Sensitivity/Impedance:**  
 Phono ..... 2.5 mV/50kΩ  
 Tuner ..... 200 mV/50kΩ  
 AUX ..... 200 mV/50kΩ  
 Tape A, B ..... 200 mV/50kΩ
- Signal to Noise Ratio (IHF, A):**  
 Phono ..... 90 dB for 2.5 mV input  
 96 dB for 5.0 mV input  
 102 dB for 10 mV input
- Tuner, AUX, Tape A, B** ..... 105 dB for 200 mV input
- Max. Input Level for Phono** 230 mV (RMS), T.H.D. 0.015% at 1,000 Hz
- Output Level/Impedance:**  
 Tape REC (Pin) ..... 200 mV/330Ω  
 (DIN) ..... 300 mV/80kΩ
- Frequency Response for Phono**..... RIAA standard curve ±0.2 dB (20 Hz to 20,000 Hz)
- Tone Control:**  
 Bass ..... ±7.5 dB at 100 Hz  
 Treble ..... ±7.5 dB at 10,000 Hz
- Loudness Control** ..... +9 dB at 100 Hz (at -30 dB VOLUME Level)
- GENERAL**  
 Power Consumption ..... 710 watts at full power  
 AC Outlet ..... Switched 2, Unswitched 1  
 Dimensions ..... W 440 mm (17-10/32")  
 H 153 mm (6-6/32")  
 D 407 mm (16-6/32")  
 Weight (Net) ..... 17.5 kg (38.6 lbs.)

\* Measured pursuant to Federal Trade Commission's Trade Regulation rule on Power Output Claims for Amplifier in U.S.A.  
 Note: Kenwood follows a policy of continuous advancements in development. For this reason specifications may be changed without notice.





**KA-801**

---

A product of  
**TRIO-KENWOOD CORPORATION**

6-17, 3-chome, Aobadai, Meguro-ku, Tokyo 153, Japan

---

**KENWOOD ELECTRONICS, INC.**

1315 E. Watsoncenter Rd, Carson, California 90745  
75 Seaview Drive, Secaucus, New Jersey 07094, U.S.A.

**TRIO-KENWOOD ELECTRONICS, N.V.**

Leuvensesteenweg 184 B-1930 Zaventem, Belgium

**TRIO-KENWOOD ELECTRONICS GmbH**

Rudolf-Braas-Str. 20, 6056 Heusenstamm, West Germany

**TRIO-KENWOOD FRANCE S.A.**

5, Boulevard Ney, 75018 Paris, France

**TRIO-KENWOOD SVENSKA AB**

Kemistvagen 10A, S-183 21 Taby, Sweden

**TRIO-KENWOOD (AUSTRALIA) PTY. LTD.**

30 Whiting St., Artarmon, N.S.W. 2064, Australia

**KENWOOD & LEE ELECTRONICS, LTD.**

Room 501, Wang Kee Building, 5th Floor, 34-37, Connaught Road, Central, Hong Kong

© 1979-2 PRINTED IN JAPAN B51-0575-00 (G) 3.659